



Operator's Manual

Printed Matter No. 8956001776

Date: 2019-07 Issue No. 02

Ratchet wrench

Valid from Serial No. C00001 to Z99999

Model:

RC3068

RC3268

RC3278

RC3678



	⚠ WARNING
	<p>To reduce risk of injury, everyone using, installing, repairing, maintaining, changing accessories on, or working near this tool MUST read and understand these instructions before performing any such task.</p> <p>DO NOT DISCARD - GIVE TO USER</p>

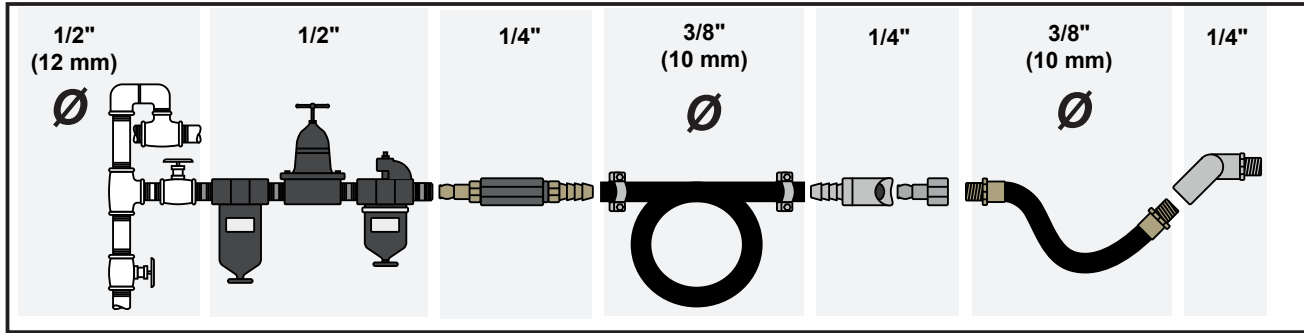

Fig. 01 : Air Diagram

	RC3068	RC3268	RC3278	RC3678
Actual air consumption (l/s)	8.5	8.5	12	12
Free speed (rpm)	280	280	190	190
Length (mm)	212	212	260	260
Min. hose size (mm)	10	10	10	10
Max. torque (Nm)	45	50	100	100
Max. working torque (Nm)	30	25	60	60
Air inlet thread size (")	1/4	1/4	1/4	1/4
	BSPP	BSPP	BSPP	BSPP

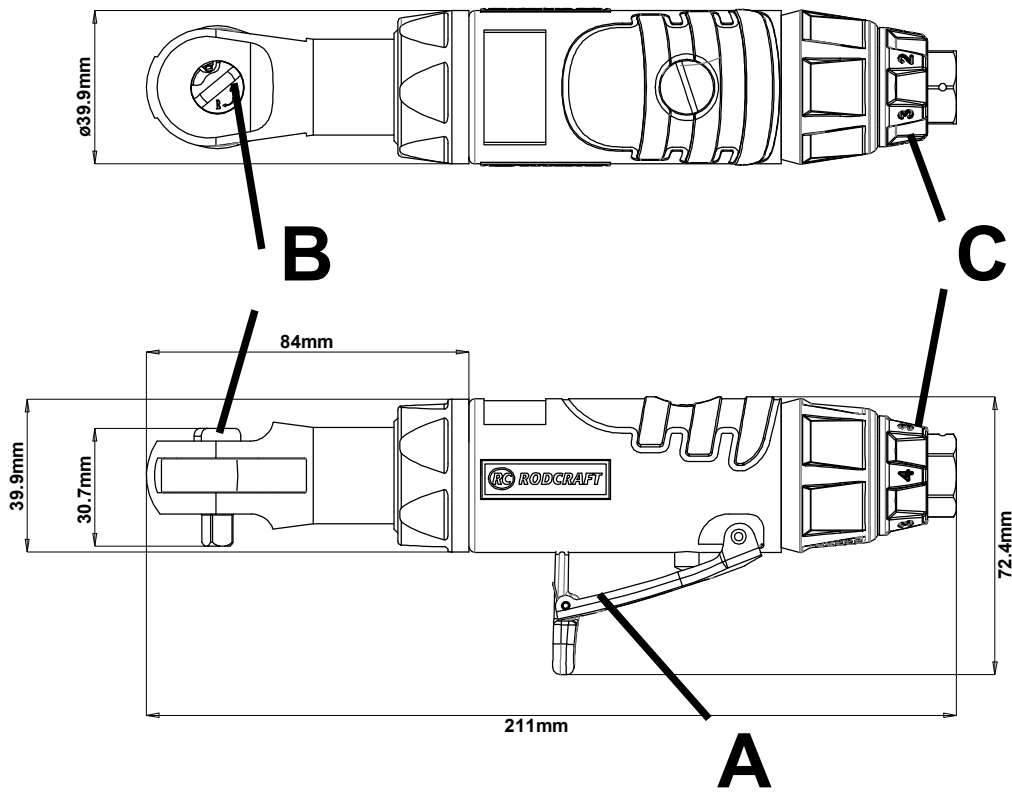

Fig. 02 : RC3068 & RC3268 DIMENSIONS

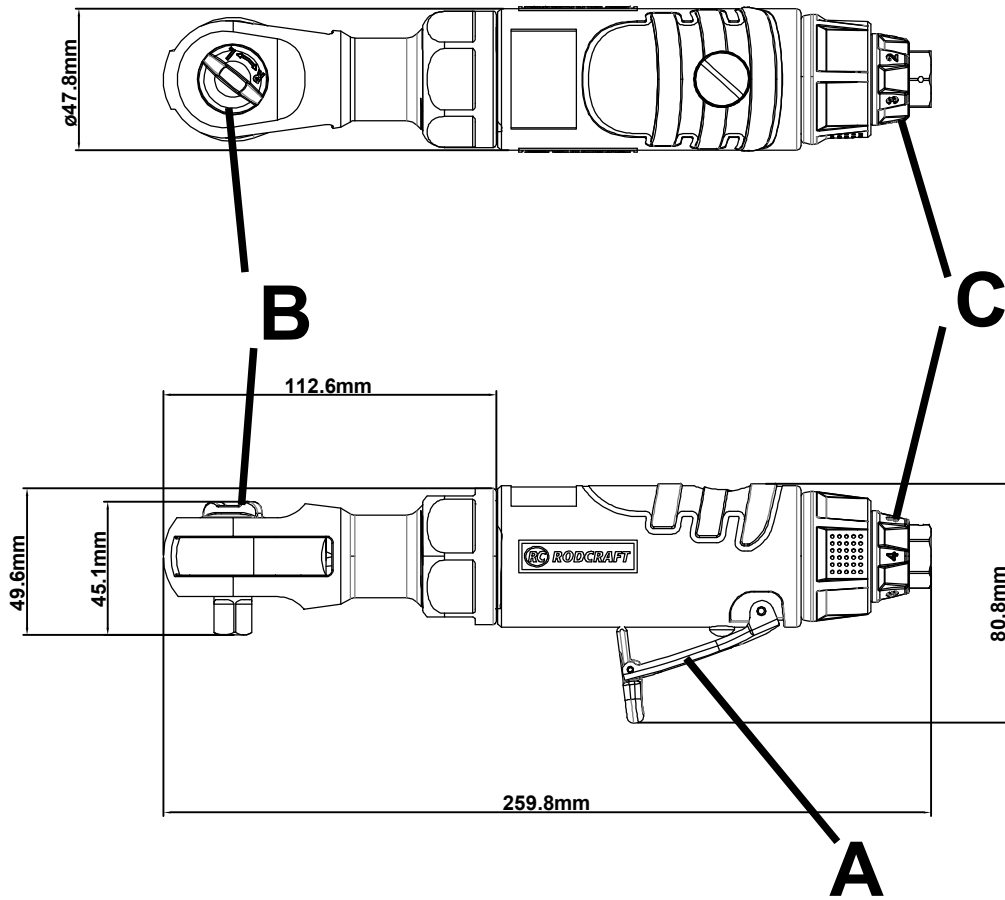

Fig. 03 : RC3278 & RC3678 DIMENSIONS

Table of Contents

EN	Operator's Manual.....	6
FR	Manuel Opérateur.....	7
DE	Betriebshandbuch.....	8
ES	Manual de funcionamiento.....	8
PT	Manual de operação.....	9
IT	Manuale d'uso.....	10
NL	Bedieningshandleiding.....	11
DA	Betjeningsvejledning.....	12
NO	Driftshåndbok.....	13
FI	Käyttöohje.....	13
EL	Εγχειρίδιο λειτουργίας.....	14
SV	Drifthandbok.....	15
RU	Руководство по эксплуатации.....	16
PL	Instrukcja obsługi.....	17
SK	Návod na prevádzku.....	18
CS	Provozní příručka.....	19
HU	Használati útmutató.....	19
SL	Priročnik za uporabo.....	20
RO	Manual de utilizare.....	21
TR	Kullanım Kılavuzu.....	22
BG	Ръководство за операция.....	23
HR	Priručnik za rad.....	24
ET	Kasutusjuhend.....	24
LT	Naudojimo vadovas.....	25
LV	Ekspluatācijas rokasgrāmata.....	26
ZH	操作手册.....	27
JA	操作マニュアル.....	28
KO	조작 설명서.....	28

Technical Data

	RC3068	RC3268	RC3278	RC3678
Air inlet thread size (")	1/4	1/4	1/4	1/4
	BSPP	BSPP	BSPP	BSPP
Free speed (rpm)	280	280	190	190
Max. torque (Nm)	45	50	100	100
Max. working torque (Nm)	30	25	60	60
Square drive (")	1/4	3/8	3/8	1/2
Weight (kg)	0.67	0.68	1.22	1.23

	RC3068	RC3268	RC3278	RC3678
Sound pressure level (dB(A))	92.9	92.9	89.2	89.2
Vibration (m/s ²)	8.5	8.5	9.2	9.2

Declarations

EU DECLARATION OF CONFORMITY

We, **Desoutter GmbH**, Edmund-Seng-Str. 3-5, 63477 Maintal, Germany, declare under our sole responsibility that the product (with name, type and serial number, see front page) is in conformity with the following Directive(s):

2006/42/EC (17/05/2006)

Harmonized standards applied:
EN ISO 11148-6:2012

Authorities can request relevant technical information from:
Pascal Roussy, R&D Manager, Ets Georges Renault, 38 rue Bobby Sands, BP10273 44818 Saint Herblain, France

Saint-Herblain,

Pascal ROUSSY

Signature of issuer

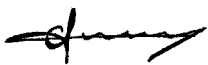

Noise and vibration

Uncertainty 3 dB(A), in accordance with ISO 15744. For Sound power level, add 11 dB(A)

Vibration standard : ISO-28927-2

These declared values were obtained by laboratory type testing in accordance with the stated standards and are suitable for comparison with the declared values of other tools tested in accordance with the same standards. These declared values are not adequate for use in risk assessments and values measured in individual work places may be higher. The actual exposure values and risk of harm experienced by an individual user are unique and depend upon the way the user works, the workpiece and the workstation design, as well upon the exposure time and the physical condition of the user.

We, **Desoutter GmbH**, cannot be held liable for the consequences of using the declared values, instead of values reflecting the actual exposure, in an individual risk assessment in a work place situation over which we have no control.

This tool may cause hand-arm vibration syndrome if its use is not adequately managed. An EU guide to managing hand-arm vibration can be found by accessing <http://www.pneurop.eu/index.php> and selecting 'Tools' then 'Legislation'.

We recommend a programme of health surveillance to detect early symptoms which may relate to noise or vibration exposure, so that management procedures can be modified to help prevent future impairment.

- ⓘ If this equipment is intended for fixtured applications: The noise emission is given as a guide to the machine-builder. Noise and vibration emission data for the complete machine should be given in the instruction manual for the machine.

Additional Vibration Information

This tool may cause hand-arm vibration syndrome if its use is not adequately managed.

This additional vibration information may be of assistance to employers in meeting their obligations (for example under EU Directive 2002/44/EC) to assess the risks to their workers arising from hand arm vibration associated with the use of this tool.

Ratchet wrenches are suitable for assembly and disassembly operations in confined spaces.

- The declared vibration value can be used to estimate vibration during rundown. Continuous ratcheting against a run-down bolt may produce a vibration emission in the range m/s² to m/s² (vibration total values).
- Only use this tool for work which other types of wrenches, which present lower vibration risks, are unable to perform satisfactorily.
- The vibration emission varies greatly with task and operator technique. Emissions outside the quoted range may occur for some applications.
- Operators should optimize their technique and select a suitable wrench in order to minimize the ratcheting time at the end of each run-down or when backing-off assembled fasteners.
- For the intended application of this tool, we estimate that normal operation should involve a ratcheting time against a run-down fastener of less than 0,5s per fastener on a hard joint and up to 3s on a soft joint.

Useful Information

Copyright

© Copyright 2019, Desoutter GmbH, Edmund-Seng-Str. 3-5, 63477 Maintal, Germany

All rights reserved. Any unauthorized use or copying of the contents or part thereof is prohibited. This applies in particular to trademarks, model denominations, part numbers and

RATCHET WRENCH

drawings. Use only authorized parts. Any damage or malfunction caused by the use of unauthorised parts is not covered by Warranty or Product Liability.

Country of origin

China

Caractéristiques techniques

	RC3068	RC3268	RC3278	RC3678
Taille de filetage entrée d'air (")	1/4	1/4	1/4	1/4
	BSPP	BSPP	BSPP	BSPP
Vitesse à vide (tr/min)	280	280	190	190
Couple max. (Nm)	45	50	100	100
Couple max. de travail (Nm)	30	25	60	60
Carré de sortie (")	1/4	3/8	3/8	1/2
Poids (kg)	0.67	0.68	1.22	1.23

	RC3068	RC3268	RC3278	RC3678
Niveau de pression acoustique (dB(A))	92.9	92.9	89.2	89.2
Vibration (m/s ²)	8.5	8.5	9.2	9.2

Déclarations

DÉCLARATION DE CONFORMITÉ UE

Nous, **Desoutter GmbH**, Edmund-Seng-Str. 3-5, 63477 Maintal, Germany, déclarons sous notre seule et entière responsabilité que le produit (dont le nom, le type et le numéro de série figurent en première page) est en conformité avec la ou les directives suivantes :
2006/42/EC (17/05/2006)

Normes harmonisées appliquées :
EN ISO 11148-6:2012

Les autorités peuvent obtenir les informations techniques pertinentes en s'adressant à :
Pascal Roussy, R&D Manager, Ets Georges Renault, 38 rue Bobby Sands, BP10273 44818 Saint Herblain, France
Saint-Herblain,

Pascal ROUSSY

Signature du déclarant

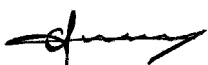

Informations supplémentaires concernant les vibrations

Cet outil peut causer un syndrome de vibrations main-bras s'il est mal utilisé.

Ces informations supplémentaires concernant les vibrations peuvent aider les employeurs à répondre à leurs obligations (par exemple dans le cadre de la directive européenne 2002/44/CE) d'évaluer les risques pour leurs employés par rapport aux vibrations main-bras associées à l'utilisation de cet outil.

Les clés à cliquet conviennent pour les opérations de montage et de démontage dans les espaces exigus.

- The declared vibration value can be used to estimate vibration during rundown. Continuous ratcheting against a run-down bolt may produce a vibration emission in the range m/s² to m/s² (vibration total values).
- N'utiliser cet outil que pour des travaux que les autres types de clés, qui présentent des risques moindres en matière de vibrations, ne peuvent pas effectuer de manière satisfaisante.
- L'émission de vibrations varie grandement avec la tâche effectuée et la technique de l'opérateur. Des émissions sortant de la plage indiquée peuvent apparaître dans certaines applications.
- Les opérateurs doivent optimiser leur technique et sélectionner une clé adaptée afin de limiter le temps de déclenchement du cliquet à la fin de chaque serrage ou lors du desserrage de fixations assemblées.
- For the intended application of this tool, we estimate that normal operation should involve a ratcheting time against a run-down fastener of less than 0,5s per fastener on a hard joint and up to 3s on a soft joint.

Informations utiles

Copyright

© Copyright 2019, Desoutter GmbH, Edmund-Seng-Str. 3-5, 63477 Maintal, Germany

Tous droits réservés. Toute utilisation non autorisée ou copie de tout ou partie du présent document est interdite. Ceci s'applique plus particulièrement aux marques de commerce, dénominations de modèles, références et schémas. Utiliser exclusivement les pièces autorisées. Tout dommage ou dysfonctionnement causé par l'utilisation d'une pièce non autorisée ne sera pas couvert par la garantie du fabricant ou la responsabilité du fait des produits.

Pays d'origine

China

Technische Daten

	RC3068	RC3268	RC3278	RC3678
Gewindegröße	1/4	1/4	1/4	1/4
Lufteinlass (")	BSPP	BSPP	BSPP	BSPP
Freie Drehzahl (min-1)	280	280	190	190
Max. Drehmoment (Nm)	45	50	100	100
Max. Arbeitsdrehmoment (Nm)	30	25	60	60
Vierkantantrieb (")	1/4	3/8	3/8	1/2
Gewicht (kg)	0.67	0.68	1.22	1.23

	RC3068	RC3268	RC3278	RC3678
Schalldruckpegel (dB(A))	92.9	92.9	89.2	89.2
Vibration (m/s ²)	8.5	8.5	9.2	9.2

Erklärungen

EU-KONFORMITÄTSERKLÄRUNG

Wir, **Desoutter GmbH**, Edmund-Seng-Str. 3-5, 63477 Maintal, Germany, erklären hiermit in alleiniger Verantwortung, dass dieses Produkt (mit Bezeichnung, Typ und Seriennummer laut Deckblatt) die Anforderungen der folgenden Richtlinie(n) erfüllt:

2006/42/EC (17/05/2006)

Angewandte harmonisierte Normen:
EN ISO 11148-6:2012

Behörden können relevante technische Informationen anfordern von:

Pascal Roussy, R&D Manager, Ets Georges Renault, 38 rue Bobby Sands, BP10273 44818 Saint Herblain, France

Saint-Herblain,

Pascal ROUSSY

Unterschrift des Ausstellers

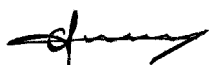

Zusätzliche Informationen zur Vibration

Dieses Werkzeug kann bei nicht angemessener Verwendung ein Hand-Arm-Vibrationssyndrom verursachen.

Diese zusätzlichen vibrationsbezogenen Informationen können Arbeitgeber dabei unterstützen, relevante Verpflichtungen zu erfüllen (wie beispielsweise in Verbindung mit der EU-Richtlinie 2002/44/EG), wenn es darum geht, die durch eine Hand-Arm-Vibration verursachten Risiken zu bewerten, denen ihr Personal beim Gebrauch dieses Werkzeugs ausgesetzt ist.

Ratschenschlüssel eignen sich für das Anziehen und Lösen von Schrauben unter beengten Platzverhältnissen.

- The declared vibration value can be used to estimate vibration during rundown. Continuous ratcheting against a run-down bolt may produce a vibration emission in the range m/s² to m/s² (vibration total values).
- Verwenden Sie dieses Werkzeug nur für Arbeiten, die von anderen Schlüsselarten, mit denen ein geringeres Vibrationsrisiko verbunden ist, nicht zufriedenstellend ausgeführt werden können.
- Die Vibrationsbelastung hängt in großem Maße von der jeweiligen Aufgabe und vom Umgang des Bedieners mit dem Werkzeug ab. Bei manchen Anwendungen können Belastungen auftreten, die außerhalb des angegebenen Bereichs liegen.
- Bediener sollten versuchen, ihre Arbeitsmethode zu optimieren und einen geeigneten Schlüssel auswählen, um die Verwendungsdauer der Ratschenfunktion am Ende jeder Einschraubphase oder beim Ausschrauben montierter Befestigungselemente zu minimieren.
- For the intended application of this tool, we estimate that normal operation should involve a ratcheting time against a run-down fastener of less than 0,5s per fastener on a hard joint and up to 3s on a soft joint.

Nützliche Informationen

Copyright

© Copyright 2019, Desoutter GmbH, Edmund-Seng-Str. 3-5, 63477 Maintal, Germany

Alle Rechte vorbehalten. Jeglicher nicht autorisierte Gebrauch sowie das Kopieren der Inhalte ganz oder in Teilen ist verboten. Dies gilt insbesondere für Handelsmarken, Modellbezeichnungen, Artikelnummern und Zeichnungen. Verwenden Sie ausschließlich Originalbauteile. Schäden oder Fehlfunktionen, die durch den Einsatz unzulässiger Bauteile entstehen, sind nicht von der Garantie oder Produkthaftung abgedeckt.

Herkunftsland

China

Datos técnicos

	RC3068	RC3268	RC3278	RC3678
Tamaño de rosca de entrada de aire (")	1/4	1/4	1/4	1/4
	BSPP	BSPP	BSPP	BSPP
Velocidad en vacío (rpm)	280	280	190	190
Máx. par (Nm)	45	50	100	100
Máx. par de trabajo (Nm)	30	25	60	60
Mango cuadrado (")	1/4	3/8	3/8	1/2

RATCHET WRENCH

	RC3068	RC3268	RC3278	RC3678
Peso (kg)	0.67	0.68	1.22	1.23
	RC3068	RC3268	RC3278	RC3678
Nivel de presión acústica (dB(A))	92.9	92.9	89.2	89.2
Vibración (m/s ²)	8.5	8.5	9.2	9.2

Declaraciones

DECLARACIÓN DE CONFORMIDAD DE LA UE

Nosotros, **Desoutter GmbH**, Edmund-Seng-Str. 3-5, 63477 Maintal, Germany, declaramos bajo nuestra única responsabilidad que el producto (con nombre, tipo y número de serie indicados en la primera página) es conforme a las siguientes Directivas:

2006/42/EC (17/05/2006)

Estándares armonizados aplicados:
EN ISO 11148-6:2012

Las autoridades pueden solicitar la correspondiente información técnica a:

Pascal Roussy, R&D Manager, Ets Georges Renault, 38 rue Bobby Sands, BP10273 44818 Saint Herblain, France

Saint-Herblain,

Pascal ROUSSY

Firma del emisor

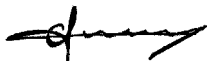

Información adicional sobre vibraciones

Esta herramienta puede causar síndrome de vibración si su uso no se administra de forma adecuada.

Esta información adicional sobre vibraciones puede ayudar a los empleadores en el cumplimiento de sus obligaciones (por ejemplo la Directiva UE 2002/44/CE) a la hora de evaluar los riesgos que sus trabajadores tienen de sufrir vibración transmitida al sistema mano-brazo como consecuencia del uso de esta herramienta.

Las llaves de impulso son adecuadas para operaciones de montaje y desmontaje en espacios reducidos.

- The declared vibration value can be used to estimate vibration during rundown. Continuous ratcheting against a run-down bolt may produce a vibration emission in the range m/s² to m/s² (vibration total values).
- Utilice esta herramienta únicamente para trabajar donde otros tipos de llaves, con menores riesgos de vibración, no puedan realizar la labor satisfactoriamente.
- La emisión de vibraciones varía notablemente dependiendo de la tarea y de la técnica del operario. En algunas aplicaciones puede excederse la gama de emisiones indicada.

- Los operarios deben optimizar su técnica y seleccionar una llave adecuada con el fin de minimizar el tiempo de trinquete al final de cada aproximación o cuando aseguren los sujetadores montados.
- For the intended application of this tool, we estimate that normal operation should involve a ratcheting time against a run-down fastener of less than 0,5s per fastener on a hard joint and up to 3s on a soft joint.

Información de utilidad

Copyright

© Copyright 2019, Desoutter GmbH, Edmund-Seng-Str. 3-5, 63477 Maintal, Germany

Todos los derechos reservados. Queda prohibido el uso autorizado o la copia total o parcial del presente contenido. En particular, esta prohibición se aplica a las marcas comerciales, las denominaciones de los modelos, los números de referencia y los gráficos. Utilice sólo piezas autorizadas. Los daños o averías causados por el uso de piezas no homologadas no serán cubiertos por la Garantía o la Responsabilidad civil del producto.

País de origen

China

Dados técnicos

	RC3068	RC3268	RC3278	RC3678
Tamanho do fio de entrada de ar (")	1/4	1/4	1/4	1/4
	BSPP	BSPP	BSPP	BSPP
Velocidade livre (rpm)	280	280	190	190
Torque máx. (Nm)	45	50	100	100
Torque máx. de funcionamiento (Nm)	30	25	60	60
Disco cuadrado (")	1/4	3/8	3/8	1/2
Peso (kg)	0.67	0.68	1.22	1.23

	RC3068	RC3268	RC3278	RC3678
Nível de pressão do som (dB(A))	92.9	92.9	89.2	89.2
vibração (m/s ²)	8.5	8.5	9.2	9.2

Declarações

DECLARAÇÃO DE CONFORMIDADE DA COMUNIDADE EUROPEIA

Nós, **Desoutter GmbH**, Edmund-Seng-Str. 3-5, 63477 Maintal, Germany, declaramos, sob nossa exclusiva responsabilidade, que este produto (com nome, tipo e número de

série, ver primeira página) está em conformidade com a(s) seguinte(s) Diretiva(s):

2006/42/EC (17/05/2006)

Normas harmonizadas aplicadas:

EN ISO 11148-6:2012

As autoridades podem solicitar informações técnicas pertinentes de:

Pascal Roussy, R&D Manager, Ets Georges Renault, 38 rue Bobby Sands, BP10273 44818 Saint Herblain, France

Saint-Herblain,

Pascal ROUSSY

Assinatura do emissor

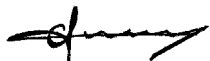

Informações Adicionais sobre Vibração

Esta ferramenta pode causar síndrome de vibração na mão e no braço se seu uso não é administrado de forma adequada.

Estas informações adicionais sobre vibração podem ser úteis para os empregadores no cumprimento das suas obrigações (por exemplo, nos termos da Diretiva UE 2002/44/CE) para avaliar os riscos aos seus trabalhadores decorrentes da vibração nas mãos e nos braços associada ao uso desta ferramenta.

Os torquímetros da catraca são adequados para operações de montagem e desmontagem em espaços confinados.

- The declared vibration value can be used to estimate vibration during rundown. Continuous ratcheting against a run-down bolt may produce a vibration emission in the range m/s^2 to m/s^2 (vibration total values).
- Apenas usar esta ferramenta para o trabalho que outros tipos de torquímetros, que apresentam menor risco de vibração, são incapazes de realizar de forma satisfatória.
- A emissão de vibração varia significativamente com a técnica do operador e tarefa. As emissões fora do intervalo referido podem ocorrer em algumas aplicações.
- Os operadores devem otimizar sua técnica e selecionar um torquímetro adequado para minimizar o tempo do movimento lento no final de cada redução ou ao recuar as fixações montadas.
- For the intended application of this tool, we estimate that normal operation should involve a ratcheting time against a run-down fastener of less than 0,5s per fastener on a hard joint and up to 3s on a soft joint.

Informações úteis

Copyright

© Copyright 2019, Desoutter GmbH, Edmund-Seng-Str. 3-5, 63477 Maintal, Germany

Todos os direitos reservados. É proibido o uso ou cópia do conteúdo ou parte dele sem autorização. Isso se aplica em particular a marcas registradas, denominações de modelo,

números de peça e desenhos. Use somente peças autorizadas. Qualquer dano ou defeito causado pelo uso de peças não autorizadas não é coberto pela Garantia ou pela Responsabilidade pelo Produto.

País de origem

China

Dati tecnici

	RC3068	RC3268	RC3278	RC3678
Dimensioni filettatura ingresso aria (")	1/4	1/4	1/4	1/4
	BSPP	BSPP	BSPP	BSPP
Velocità libera (giri/min)	280	280	190	190
Coppia (Nm) max.	45	50	100	100
Coppia operativa (Nm) max.	30	25	60	60
Azionamento quadrato (")	1/4	3/8	3/8	1/2
Peso (kg)	0.67	0.68	1.22	1.23

	RC3068	RC3268	RC3278	RC3678
Livello di pressione acustica (dB(A))	92.9	92.9	89.2	89.2
Vibrazione (m/s^2)	8.5	8.5	9.2	9.2

Dichiarazioni

DICHIARAZIONE DI CONFORMITÀ UE

Desoutter GmbH, Edmund-Seng-Str. 3-5, 63477 Maintal, Germany, dichiara sotto la propria esclusiva responsabilità che il prodotto (del tipo e con il numero di serie riportati nella pagina a fronte) è conforme alle seguenti Direttive: **2006/42/EC (17/05/2006)**

Norme armonizzate applicate:

EN ISO 11148-6:2012

Le autorità possono richiedere le informazioni tecniche pertinenti da:

Pascal Roussy, R&D Manager, Ets Georges Renault, 38 rue Bobby Sands, BP10273 44818 Saint Herblain, France

Saint-Herblain,

Pascal ROUSSY

Firma del dichiarante

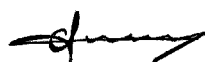

Ulteriori informazioni sulle vibrazioni

Se non è gestito correttamente, l'utilizzo del presente utensile può causare la sindrome da vibrazioni mano-braccio.

Le presenti informazioni aggiuntive sulle vibrazioni possono essere di ausilio ai datori di lavoro nell'espletamento dei relativi propri contrattuali (per esempio in conformità alla direttiva UE 2002/44/CE) per valutare i rischi per i lavoratori derivanti dalle vibrazioni mano-braccio associate all'impiego di questo utensile.

Gli avvitadadi a cricchetto sono adatti per le operazioni di assemblaggio e disassemblaggio in spazi ristretti.

- The declared vibration value can be used to estimate vibration during rundown. Continuous ratcheting against a run-down bolt may produce a vibration emission in the range m/s^2 to m/s^2 (vibration total values).
- Utilizzare questo utensile esclusivamente per lavorazioni che non possono essere eseguite in modo soddisfacente con altri tipi di avvitadadi, che presentano rischi vibratorio inferiori.
- Le emissioni vibratorie variano notevolmente a seconda del compito e della tecnica adottata dall'operatore. Per alcune applicazioni possono verificarsi emissioni non comprese nell'intervallo citato.
- Gli operatori devono ottimizzare la tecnica adottata e scegliere un avvitadadi adatto al fine di minimizzare il tempo di rotazione del cricchetto al termine di ciascun serraggio o durante l'allontanamento dai dispositivi di fissaggio assemblati.
- For the intended application of this tool, we estimate that normal operation should involve a ratcheting time against a run-down fastener of less than 0,5s per fastener on a hard joint and up to 3s on a soft joint.

Informazioni utili

Copyright

© Copyright 2019, Desoutter GmbH, Edmund-Seng-Str. 3-5, 63477 Maintal, Germany

Tutti i diritti riservati. Qualsiasi utilizzo o copia non autorizzati dei contenuti o di parte di questi è vietato. Ciò vale in particolare per marchi registrati, denominazioni dei modelli, numeri di componente e diagrammi. Utilizzare solo componenti autorizzati. Un eventuale danneggiamento o difetto di funzionamento causato dall'utilizzo di componenti non autorizzati non è coperto dalla garanzia o dalla responsabilità per danni dovuti a prodotti difettosi.

Paese di origine

China

Technische gegevens

	RC3068	RC3268	RC3278	RC3678
Draadgrootte luchtinlaat (")	1/4	1/4	1/4	1/4
	BSPP	BSPP	BSPP	BSPP
Onbelast toerental (omw/min)	280	280	190	190
Max. koppel (Nm)	45	50	100	100
Max. werkkoppel (Nm)	30	25	60	60
Vierkanten aandrijving (")	1/4	3/8	3/8	1/2
Gewicht (kg)	0.67	0.68	1.22	1.23

	RC3068	RC3268	RC3278	RC3678
Geluidsdrukkniveau (dB(A))	92.9	92.9	89.2	89.2
Trilling (m/s^2)	8.5	8.5	9.2	9.2

Verklaringen

EU CONFORMITEITSVERKLARING

Wij, **Desoutter GmbH**, Edmund-Seng-Str. 3-5, 63477 Maintal, Germany verklaren dat het product (met naam, type- en serienummer, zie voorpagina) in overeenstemming is met de volgende richtlijn(en):

2006/42/EC (17/05/2006)

De volgende geharmoniseerde normen werden gehanteerd:
EN ISO 11148-6:2012

Autoriteiten kunnen relevante technische informatie opvragen van:

Pascal Roussy, R&D Manager, Ets Georges Renault, 38 rue Bobby Sands, BP10273 44818 Saint Herblain, France

Saint-Herblain,

Pascal ROUSSY

Handtekening van de opsteller



Aanvullende informatie over trillingen

Indien dit gereedschap niet naar behoren wordt gebruikt, kan dit het hand-arm vibratiesyndroom veroorzaken.

Deze aanvullende informatie over trillingen kan werkgevers helpen bij het voldoen aan hun verplichtingen (zoals uiteengezet in EU-richtlijn 2002/44/EC) als het gaat om het beoordelen van de kans op het ontwikkelen van het hand-arm vibratiesyndroom als gevolg van het gebruik van dit gereedschap.

Ratelsleutels zijn geschikt voor montage en demontagewerkzaamheden in afgesloten ruimtes.

- The declared vibration value can be used to estimate vibration during rundown. Continuous ratcheting against a run-down bolt may produce a vibration emission in the range m/s^2 to m/s^2 (vibration total values).
- Gebruik dit gereedschap uitsluitend voor werk dat met andere soorten sleutels, die de gebruiker aan minder trillingsrisico's blootstellen, niet naar behoren kan worden uitgevoerd.
- Het trillingsniveau varieert aanzienlijk per taak en per gebruikte techniek. Trillingen die het aangegeven bereik overschrijden treden mogelijk op bij bepaalde toepassingen.
- Bedieners dienen hun techniek te optimaliseren en een geschikte sleutel te selecteren, voor het minimaliseren van de aanhaaltijd of voor het losdraaien van gemonteerde bevestigingsdelen.
- For the intended application of this tool, we estimate that normal operation should involve a ratcheting time against a run-down fastener of less than 0,5s per fastener on a hard joint and up to 3s on a soft joint.

Nuttige informatie

Copyright

© Copyright 2019, Desoutter GmbH, Edmund-Seng-Str. 3-5, 63477 Maintal, Germany

Alle rechten voorbehouden. Onrechtmatig gebruik of het kopiëren van de inhoud of een deel hiervan is verboden. Dit is met name van toepassing op handelsmerken, modelnamen, onderdeelnummers en tekeningen. Gebruik uitsluitend onderdelen van Atlas Copco. Schade of defecten als gevolg van het gebruik van onderdelen van derden vallen niet onder de garantie.

Land van oorsprong

China

Teknische data

	RC3068	RC3268	RC3278	RC3678
Lufttandsugets gevindstr. (")	1/4	1/4	1/4	1/4
	BSPP	BSPP	BSPP	BSPP
Frihastighed (o./min.)	280	280	190	190
Maks. drejningsmoment (Nm)	45	50	100	100
Maks. driftsmoment (Nm)	30	25	60	60
Firkantdrev (")	1/4	3/8	3/8	1/2
Vægt (kg)	0.67	0.68	1.22	1.23

	RC3068	RC3268	RC3278	RC3678
Lydtryksniveau (dB(A))	92.9	92.9	89.2	89.2
Vibration (m/s^2)	8.5	8.5	9.2	9.2

Erklæringer

EU OVERENSSTEMMELSESERKLÆRING

Vi, **Desoutter GmbH**, Edmund-Seng-Str. 3-5, 63477 Maintal, Germany, erklærer, under eneansvar, at produktet (med navn, type og serienummer på forsiden) er i overensstemmelse med følgende direktiv(er):
2006/42/EC (17/05/2006)

Harmoniserede standarder anvendt:

EN ISO 11148-6:2012

Myndigheder kan rekvirere relevant teknisk information fra: Pascal Roussy, R&D Manager, Ets Georges Renault, 38 rue Bobby Sands, BP10273 44818 Saint Herblain, France

Saint-Herblain,

Pascal ROUSSY

Udstederens underskrift

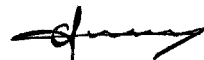

Yderligere vibrationsinformation

Dette værktøj kan forårsage hånd-arm-vibrationssyndrom, hvis anvendelse af værktøjet ikke styres tilstrækkeligt.

Den ekstra vibrationsinformation kan være til hjælp for arbejdsgiverne mht. opfyldelse af deres pligter (f.eks. under EU-direktivet 2002/44/EØF) med henblik på at evaluere risiciene for deres medarbejdere som følge af hånd-arm-vibration i forbindelse med brug af dette værktøj.

Skraldenøgler er egnede til samling og adskillelse på trange steder.

- The declared vibration value can be used to estimate vibration during rundown. Continuous ratcheting against a run-down bolt may produce a vibration emission in the range m/s^2 to m/s^2 (vibration total values).
- Brug kun dette værktøj til arbejde, som andre typer skruenøgler, der udgør en lavere vibrationsrisiko, ikke kan udføre tilfredsstillende.
- Vibrationsemissionen varierer stærkt med opgaven og operatørens teknik. Emissioner uden for det anførte område kan opstå for nogle anvendelser.
- Operatører bør optimere deres teknik og vælge en egnet skrue nøgle med henblik på at minimere tilspændingstiden til sidst på hver iskruning eller når samlede befæstelser afdrejes.
- For the intended application of this tool, we estimate that normal operation should involve a ratcheting time against a run-down fastener of less than 0,5s per fastener on a hard joint and up to 3s on a soft joint.

Nyttig informasjon

Copyright

© Copyright 2019, Desoutter GmbH, Edmund-Seng-Str. 3-5, 63477 Maintal, Germany

Alle rettigheter forbeholdes. All uautoriseret brug eller kopiering af indholdet eller dele deraf er forbudt. Dette gælder især varemærker, modelbetegnelser, reservedelenumre og tegninger. Brug kun autoriserede reservedele. All skade eller fejlfunktion som følge af brug af uautoriserede dele dækkes hverken af garantien eller produktansvaret.

Oprindelsesland

China

Tekniske data

	RC3068	RC3268	RC3278	RC3678
Gjengestørrelse luftinntak (")	1/4	1/4	1/4	1/4
	BSPP	BSPP	BSPP	BSPP
Fri hastighet (opm)	280	280	190	190
Maks. dreiemoment (Nm)	45	50	100	100
Maks. arbeidsmoment (Nm)	30	25	60	60
Firkantdrev (")	1/4	3/8	3/8	1/2
Vekt (kg)	0.67	0.68	1.22	1.23

	RC3068	RC3268	RC3278	RC3678
Lydtryknivå (dB(A))	92.9	92.9	89.2	89.2
Vibrasjon (m/s ²)	8.5	8.5	9.2	9.2

Erklæringer

EU-SAMSVARERKLÆRING

Vi, **Desoutter GmbH**, Edmund-Seng-Str. 3-5, 63477 Maintal, Germany, erklærer på vårt eneansvar at vårt produkt (med type- og serienummer, se forsiden) er i samsvar med de følgende direktiv(er):

2006/42/EC (17/05/2006)

Benyttede harmoniserte standarder:

EN ISO 11148-6:2012

Myndigheter kan be om relevant teknisk informasjon fra: Pascal Roussy, R&D Manager, Ets Georges Renault, 38 rue Bobby Sands, BP10273 44818 Saint Herblain, France

Saint-Herblain,

Pascal ROUSSY

Utstederens signatur

Ekstra vibrasjonsinformasjon

Dette verktøyet kan forårsake hånd-arm-vibrasjonssyndrom hvis det ikke håndteres riktig.

Denne ekstra vibrasjonsinformasjonen kan være til hjelp for ansatte for å oppfylle forpliktelsene sine (for eksempel under EU-direktiv 2002/44/EC) om å vurdere risikoene for arbeiderne som oppstår ut fra hånd-arm-vibrasjon i forbindelse med bruken av dette verktøyet.

Ratsjnøkler egner seg til monterings- og demonteringsoperasjoner på innelukkede plasser.

- The declared vibration value can be used to estimate vibration during rundown. Continuous ratcheting against a run-down bolt may produce a vibration emission in the range m/s² to m/s² (vibration total values).
- Bruk kun dette verktøyet til arbeid som andre typer nøkler, som har lavere vibrasjonsrisikoer, ikke er i stand til å utføre tilfredsstillende.
- Vibrasjonsutslippet varierer mye med oppgave og operatorteknikk. Utslipp utenfor det oppgitte området kan oppstå for noen bruksområder.
- Operatørene bør optimalisere sin teknikk og velge en egnet nøkkel for å minimalisere ratsjingstiden på slutten av hver drift eller ved uttrekking av monterte festeenheter.
- For the intended application of this tool, we estimate that normal operation should involve a ratcheting time against a run-down fastener of less than 0,5s per fastener on a hard joint and up to 3s on a soft joint.

Nyttig informasjon

Opphavsrett

© Copyright 2019, Desoutter GmbH, Edmund-Seng-Str. 3-5, 63477 Maintal, Germany

Alle rettigheter forbeholdes. All uautorisert bruk eller kopiering av innholdet eller en del av dette er forbudt. Dette gjelder spesielt for varemerker, modellbetegnelser, delenumre og tegninger. Bruk kun autoriserte deler. Skader eller feilfunksjoner som forårsakes av bruk av uautoriserte deler, dekkes ikke av garantien eller produktansvaret.

Opphavsland

China

Tekniset tiedot

	RC3068	RC3268	RC3278	RC3678
Ilmanoton kierteen koko (tuumaa)	1/4	1/4	1/4	1/4

	RC3068	RC3268	RC3278	RC3678
	BSPP	BSPP	BSPP	BSPP
Vapaat kierrokset (kierr./min)	280	280	190	190
Maks. vääntö (Nm)	45	50	100	100
Maks. käyttöväätömomentti (Nm)	30	25	60	60
Neliöakseli (tuumaa)	1/4	3/8	3/8	1/2
Paino (kg)	0.67	0.68	1.22	1.23

	RC3068	RC3268	RC3278	RC3678
Äänenpainetaso (dB(A))	92.9	92.9	89.2	89.2
Tärinä (m/s ²)	8.5	8.5	9.2	9.2

Vakuutukset

EU-VAATIMUSTENMUKAISUUSVAKUUTUS

Me, **Desoutter GmbH**, Edmund-Seng-Str. 3-5, 63477 Maintal, Germany, vakuutamme vastuullisesti, että tuote (nimi, tyyppi ja sarjanumero, katso etusivu) on yhdenmukainen seuraavien direktiivien kanssa:

2006/42/EC (17/05/2006)

Sovellettu harmonisointuja standardeja:

EN ISO 11148-6:2012

Viranomaiset voivat pyytää asiaan liittyvät tekniset tiedot kohteesta:

Pascal Roussy, R&D Manager, Ets Georges Renault, 38 rue Bobby Sands, BP10273 44818 Saint Herblain, France

Saint-Herblain,

Pascal ROUSSY

Julkaisijan allekirjoitus



Lisätietoja tärinästä

Tämä työkalu voi aiheuttaa käden täriseistä, jos sitä ei käytetä oikealla tavalla.

Nämä lisätiedot tärinästä voivat auttaa työnantajia noudattamaan velvollisuuksiaan (esim. EU Direktiivin 2002/44/EC mukaan), arvioidessaan työntekijöiden altistumista käsien tärinän vaaralle tämän työkalun käytöstä johtuen.

Holkkiavaimet sopivat kiinnitys- ja irrotustoimintoihin ahtaissa tiloissa.

- The declared vibration value can be used to estimate vibration during rundown. Continuous ratcheting against a run-down bolt may produce a vibration emission in the range m/s² to m/s² (vibration total values).
- Käytä tätä työkalua töihin, joissa toisentyypiset holkkiavaimet, joiden tärinäriskit ovat pienemmät, eivät toimi tyydyttävällä tavalla.

- Tärinäpäästöt vaihtelevat huomattavasti tehtävän ja käyttäjän toiminnan mukaan. Päästöt mainitun alueen ulkopuolella voivat syntyä tietyissä sovelluksissa.
- Käyttäjien tulee optimoida tekniikkansa ja valita sopiva avain räikkätoiminnan ajan minimoimiseksi upotuksen lopulla tai kiinnikkeiden irrotuksen yhteydessä.
- For the intended application of this tool, we estimate that normal operation should involve a ratcheting time against a run-down fastener of less than 0,5s per fastener on a hard joint and up to 3s on a soft joint.

Hyödyllistä tietoa

Copyright

© Copyright 2019, Desoutter GmbH, Edmund-Seng-Str. 3-5, 63477 Maintal, Germany

Kaikki oikeudet pidätetään. Sisällön tai sen osan luvaton käyttö tai kopiointi on kielletty. Se koskee erityisesti tavaramerkkejä, mallinimityksiä, osanumeroita ja piirustuksia. Käytä vain hyväksytyjä varaosia. Takuu tai tuotevastuu ei korvaa mitään vaurioita tai toimintahäiriöitä, jotka johtuvat muiden kuin hyväksytyjen varaosien käytöstä.

Alkuperäismaa

China

Τεχνικά δεδομένα

	RC3068	RC3268	RC3278	RC3678
Μέγεθος σπειρώματος εισαγωγής αέρα (")	1/4	1/4	1/4	1/4
	BSPP	BSPP	BSPP	BSPP
Στροφές χωρίς φορτίο (σ.α.λ.)	280	280	190	190
Μέγ. ροπή (Nm)	45	50	100	100
Μέγ. ροπή λειτουργίας (Nm)	30	25	60	60
Τετράγωνο καρέ (")	1/4	3/8	3/8	1/2
Βάρος (kg)	0.67	0.68	1.22	1.23

	RC3068	RC3268	RC3278	RC3678
Στάθμη ηχητικής πίεσης (dB(A))	92.9	92.9	89.2	89.2
Κραδασμοί (m/s ²)	8.5	8.5	9.2	9.2

Δηλώσεις

ΔΗΛΩΣΗ ΣΥΜΜΟΡΦΩΣΗΣ ΕΕ

Εμείς, η **Desoutter GmbH**, Edmund-Seng-Str. 3-5, 63477 Maintal, Germany, δηλώνουμε με αποκλειστική ευθύνη μας ότι το προϊόν (με ονομασία, τύπο και σειριακό αριθμό, βλ. εξώφυλλο) συμμορφώνεται με την/τις παρακάτω Οδηγία/ες: **2006/42/EC (17/05/2006)**

Ισχύοντα εναρμονισμένα πρότυπα:
EN ISO 11148-6:2012

Οι αρχές μπορούν να ζητήσουν τις σχετικές τεχνικές πληροφορίες από:
Pascal Roussy, R&D Manager, Ets Georges Renault, 38 rue Bobby Sands, BP10273 44818 Saint Herblain, France

Saint-Herblain,

Pascal ROUSSY

Υπογραφή εκδότη

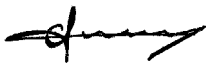

Additional Vibration Information

This tool may cause hand-arm vibration syndrome if its use is not adequately managed.

This additional vibration information may be of assistance to employers in meeting their obligations (for example under EU Directive 2002/44/EC) to assess the risks to their workers arising from hand arm vibration associated with the use of this tool.

Ratchet wrenches are suitable for assembly and disassembly operations in confined spaces.

- The declared vibration value can be used to estimate vibration during rundown. Continuous ratcheting against a run-down bolt may produce a vibration emission in the range m/s^2 to m/s^2 (vibration total values).
- Only use this tool for work which other types of wrenches, which present lower vibration risks, are unable to perform satisfactorily.
- The vibration emission varies greatly with task and operator technique. Emissions outside the quoted range may occur for some applications.
- Operators should optimize their technique and select a suitable wrench in order to minimize the ratcheting time at the end of each run-down or when backing-off assembled fasteners.
- For the intended application of this tool, we estimate that normal operation should involve a ratcheting time against a run-down fastener of less than 0,5s per fastener on a hard joint and up to 3s on a soft joint.

Χρήσιμες πληροφορίες

Πνευματικά δικαιώματα

© Copyright 2019, Desoutter GmbH, Edmund-Seng-Str. 3-5, 63477 Maintal, Germany

Με την επιφύλαξη παντός δικαιώματος. Απαγορεύεται κάθε μη εξουσιοδοτημένη χρήση ή αντιγραφή των περιεχομένων ή μέρους τους. Αυτό ισχύει ιδίως για τα εμπορικά σήματα, τις επωνυμίες μοντέλων, τους αριθμούς ανταλλακτικών και τα σχεδιαγράμματα. Χρησιμοποιείτε μόνο εγκεκριμένα ανταλλακτικά. Οποιαδήποτε ζημία ή δυσλειτουργία λόγω μη εγκεκριμένων ανταλλακτικών δεν καλύπτεται από την Εγγύηση ή την Ευθύνη για τα Προϊόντα.

Χώρα προέλευσης

China

Tekniska data

	RC3068	RC3268	RC3278	RC3678
Luftgång gängstorlek (")	1/4	1/4	1/4	1/4
	BSPP	BSPP	BSPP	BSPP
Tomgångshastighet (rpm)	280	280	190	190
Max. vridmoment (Nm)	45	50	100	100
Max. vridmoment drift (Nm)	30	25	60	60
Fyrkantfäste (")	1/4	3/8	3/8	1/2
Vikt (kg)	0.67	0.68	1.22	1.23

	RC3068	RC3268	RC3278	RC3678
Ljudtryck (dB(A))	92.9	92.9	89.2	89.2
Vibration (m/s^2)	8.5	8.5	9.2	9.2

Deklarationer

EU-FÖRSÄKRAN OM ÖVERENSSTÄMMELSE

Vi, **Desoutter GmbH**, Edmund-Seng-Str. 3-5, 63477 Maintal, Germany, försäkrar under eget ansvar att produkten (med namn, typ och serienummer, se framsida) uppfyller följande direktiv:

2006/42/EC (17/05/2006)

Tillämpade harmoniserade standarder:
EN ISO 11148-6:2012

Myndigheter kan begära relevant teknisk information från: Pascal Roussy, R&D Manager, Ets Georges Renault, 38 rue Bobby Sands, BP10273 44818 Saint Herblain, France

Saint-Herblain,

Pascal ROUSSY

Utfärdarens underskrift



Ytterligare information om vibration

Detta verktyg kan orsaka syndromet hand-armvibrationer om det inte används korrekt.

Denna ytterligare vibrationsinformation kan vara till hjälp för arbetsgivare som vill uppfylla sina åtaganden (till exempel enligt EU-direktiv 2002/44/EG) för att bedöma riskerna för sina anställda till följd av syndromet hand-armvibrationer som associeras med att använda detta verktyg.

Spärnycklar är lämpliga för montering och demontering i trånga utrymmen.

- The declared vibration value can be used to estimate vibration during rundown. Continuous ratcheting against a run-down bolt may produce a vibration emission in the range m/s^2 to m/s^2 (vibration total values).
- Använd endast detta verktyg tillsammans med andra typer av skruvdragare, som har lägre vibrationsrisker och inte fungerar tillfredsställande.
- Vibrationsemissionen varierar stort med uppgiften samt operatörens teknik. Emissioner utanför det angivna intervall kan inträffa för vissa tillämpningar.
- Operatörer bör optimera sin teknik och välja en lämplig skruvdragare för att minimera kuggningstiden när en bult är förbrukad eller vid avbackning av monterade fästelement.
- For the intended application of this tool, we estimate that normal operation should involve a ratcheting time against a run-down fastener of less than 0,5s per fastener on a hard joint and up to 3s on a soft joint.

Användbar information

Copyright

© Copyright 2019, Desoutter GmbH, Edmund-Seng-Str. 3-5, 63477 Maintal, Germany

Med ensamrätt. All obehörig användning eller kopiering av innehållet eller del därav är förbjuden. Detta gäller särskilt varumärken, modellbeteckningar, artikelnummer och ritningar. Använd bara godkända delar. Skador eller fel som orsakas genom användning av icke godkända delar täcks inte av garanti eller företagets produktansvar.

Ursprungsland

China

Технические данные

	RC3068	RC3268	RC3278	RC3678
Размер резьбы воздуховпускного отверстия (")	1/4	1/4	1/4	1/4
	BSPP	BSPP	BSPP	BSPP
Скорость холостого хода (об/мин)	280	280	190	190

	RC3068	RC3268	RC3278	RC3678
Макс. крутящий момент (Нм)	45	50	100	100
Макс. рабочий крутящий момент (Нм)	30	25	60	60
Квадратный хвостовик (")	1/4	3/8	3/8	1/2
Масса (кг)	0.67	0.68	1.22	1.23

	RC3068	RC3268	RC3278	RC3678
Уровень звукового давления (дБ(А))	92.9	92.9	89.2	89.2
Вибрация (m/s^2)	8.5	8.5	9.2	9.2

Декларации

ДЕКЛАРАЦИЯ О СООТВЕТСТВИИ ЕС

Компания **Desoutter GmbH**, Edmund-Seng-Str. 3-5, 63477 Maintal, Germany, с полной ответственностью заявляет, что данное изделие (наименование, тип и серийный номер которого указаны на титульном листе) соответствует положениям следующих директив: **2006/42/ЕС (17/05/2006)**

Были применены следующие согласованные стандарты: **EN ISO 11148-6:2012**

Официальные органы могут запросить соответствующую техническую информацию у следующих лиц:
 Pascal Roussy, R&D Manager, Ets Georges Renault, 38 rue Bobby Sands, BP10273 44818 Saint Herblain, France
 Saint-Herblain,

Pascal ROUSSY

Подпись заявителя



Дополнительная информация по вибрации

При ненадлежащей манере использования данный инструмент может вызвать вибрационный синдром рук.

Эта дополнительная информация по вибрации может помочь работодателям в соблюдении их обязательств (например, согласно Директиве ЕС 2002/44/ЕС) по оценке рисков для их работников в результате вибрационного воздействия на руки, связанного с использованием данного инструмента.

Трещоточные гаечные ключи подходят для операций сборки и демонтажа в ограниченном пространстве.

RATCHET WRENCH

- The declared vibration value can be used to estimate vibration during rundown. Continuous ratcheting against a run-down bolt may produce a vibration emission in the range m/s^2 to m/s^2 (vibration total values).
- Данный инструмент допускается использовать для проведения только тех видов работ, которые невозможно выполнить на надлежащем уровне с помощью гаечных ключей другого типа, подразумевающих меньшие риски вибрационного воздействия.
- Уровень вибрационной отдачи существенно различается в зависимости от выполняемой задачи и метода работы оператора. В некоторых областях применения значения отдачи могут выходить за пределы указанного диапазона.
- Операторам следует оптимизировать метод своей работы и выбирать подходящий гаечный ключ, чтобы свести к минимуму время прокручивания трещотки в конце каждой операции закручивания или при вывинчивании установленных крепежных элементов.
- For the intended application of this tool, we estimate that normal operation should involve a ratcheting time against a run-down fastener of less than 0,5s per fastener on a hard joint and up to 3s on a soft joint.

Полезные сведения

Авторское право

© Авторское право, 2019, Desoutter GmbH, Edmund-Seng-Str. 3-5, 63477 Maintal, Germany

Все права защищены. Любое несанкционированное использование или копирование содержимого настоящего документа или его части запрещено. В частности, это относится к товарным знакам, названиям моделей, номерам деталей и чертежам. Используйте только разрешенные запасные части. Любые повреждения или неисправности, возникшие в результате использования неразрешенных запасных частей, не попадают под действие гарантии и ответственности производителя за продукцию.

Страна происхождения

China

Dane techniczne

	RC3068	RC3268	RC3278	RC3678
Rozmiar gwintu wlotu powietrza (")	1/4	1/4	1/4	1/4
	BSPP	BSPP	BSPP	BSPP
Prędkość swobodna (obr./min)	280	280	190	190
Maks. moment obrotowy (Nm)	45	50	100	100

	RC3068	RC3268	RC3278	RC3678
Maks. roboczy moment obrotowy (Nm)	30	25	60	60
Napęd kwadratowy (")	1/4	3/8	3/8	1/2
Waga (kg)	0.67	0.68	1.22	1.23

	RC3068	RC3268	RC3278	RC3678
Poziom ciśnienia akustycznego (dB(A))	92.9	92.9	89.2	89.2
Wibracje (m/s^2)	8.5	8.5	9.2	9.2

Deklaracje

DEKLARACJA ZGODNOŚCI UE

Firma **Desoutter GmbH**, Edmund-Seng-Str. 3-5, 63477 Maintal, Germany oświadcza na swoją wyłączną odpowiedzialność, że produkt (którego nazwę, typ i numer seryjny podano na stronie tytułowej) jest zgodny z postanowieniami następującej dyrektywy (dyrektyw): **2006/42/EC (17/05/2006)**

Zastosowane normy zharmonizowane:
EN ISO 11148-6:2012

Władze mogą zażądać istotnych informacji technicznych od: Pascal Roussy, R&D Manager, Ets Georges Renault, 38 rue Bobby Sands, BP10273 44818 Saint Herblain, France

Saint-Herblain,

Pascal ROUSSY

Podpis wystawcy



Dodatkowe informacje na temat drgań

Niniejsze narzędzie może powodować wystąpienie syndromu drgań rąk-ramion (HAVS), jeśli nie jest używane we właściwy sposób.

Zamieszczone tu dodatkowe informacje na temat drgań mogą ułatwić pracodawcom wywiązywanie się z obowiązku (ciążącego na nich na przykład w świetle Dyrektywy Unii Europejskiej 2002/44/EC) dokonywania oceny zagrożeń dla zdrowia pracowników, wynikających z występowania drgań rąk i ramion w związku z używaniem niniejszego narzędzia.

Klucze z mechanizmem zapadkowym nadają się do wykonywania operacji montażowych i demontażowych w ograniczonych przestrzeniach.

- The declared vibration value can be used to estimate vibration during rundown. Continuous ratcheting against a run-down bolt may produce a vibration emission in the range m/s^2 to m/s^2 (vibration total values).
- Niniejszego narzędzia należy używać wyłącznie do wykonywania prac, których inne rodzaje kluczy, stwarzające niższe zagrożenie drganiami, nie są w stanie wykonać zadowalająco.

- Emisja drgań różni się znacznie w zależności od wykonywanego zadania i techniki pracy operatora. W przypadku niektórych zastosowań wielkość emisji drgań może wykraczać poza podany zakres.
- Operatorzy powinni optymalizować swoją technikę pracy i wybierać odpowiedni klucz, tak aby ograniczyć do minimum czas przeskakowania mechanizmu zapadkowego przy końcu wkręcania każdego elementu złącznego lub podczas wykręcania zamontowanych elementów złącznych.
- For the intended application of this tool, we estimate that normal operation should involve a ratcheting time against a run-down fastener of less than 0,5s per fastener on a hard joint and up to 3s on a soft joint.

Przydatne informacje

Prawa autorskie

© Copyright 2019, Desoutter GmbH, Edmund-Seng-Str. 3-5, 63477 Maintal, Germany

Wszelkie prawa zastrzeżone. Wszelkie nieuprawnione użytkowanie lub kopiowanie zawartości niniejszego dokumentu bądź jego części jest zabronione. Dotyczy to w szczególności znaków towarowych, oznaczeń modeli, numerów części oraz rysunków. Używać wyłącznie zatwierdzonych części zamiennych. Wszelkie uszkodzenia lub wadliwe działanie spowodowane używaniem niezatwierdzonych części zamiennych nie są objęte gwarancją ani odpowiedzialnością z tytułu rękojmi za wady produktu.

Kraj pochodzenia

China

Technické údaje

	RC3068	RC3268	RC3278	RC3678
Vel'kosť závitu vstupu vzduchu (")	1/4	1/4	1/4	1/4
	BSPP	BSPP	BSPP	BSPP
Rýchlosť voľnobehu (ot./min)	280	280	190	190
Max. moment (Nm)	45	50	100	100
Max. pracovný moment (Nm)	30	25	60	60
Štvorcové upínadlo (")	1/4	3/8	3/8	1/2
Hmotnosť (kg)	0.67	0.68	1.22	1.23

	RC3068	RC3268	RC3278	RC3678
Úroveň tlaku hluku (dB(A))	92.9	92.9	89.2	89.2
Vibrácie (m/s ²)	8.5	8.5	9.2	9.2

Vyhľadania

VYHLÁSENIE EU O ZHODE

My, **Desoutter GmbH**, Edmund-Seng-Str. 3-5, 63477 Maintal, Germany, vyhlasujeme na našu výhradnú zodpovednosť, že výrobok (s názvom, typovým a výrobným číslom, pozri prednú stranu), je v zhode s nasledovnou(ými) smernicou(ami):

2006/42/EC (17/05/2006)

Použité harmonizované normy:

EN ISO 11148-6:2012

Orgány si môžu vyžiadať príslušné technické informácie od: Pascal Roussy, R&D Manager, Ets Georges Renault, 38 rue Bobby Sands, BP10273 44818 Saint Herblain, France

Saint-Herblain,

Pascal ROUSSY

Podpis emitenta

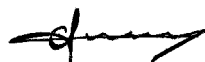

Additional Vibration Information

This tool may cause hand-arm vibration syndrome if its use is not adequately managed.

This additional vibration information may be of assistance to employers in meeting their obligations (for example under EU Directive 2002/44/EC) to assess the risks to their workers arising from hand arm vibration associated with the use of this tool.

Ratchet wrenches are suitable for assembly and disassembly operations in confined spaces.

- The declared vibration value can be used to estimate vibration during rundown. Continuous ratcheting against a run-down bolt may produce a vibration emission in the range m/s² to m/s² (vibration total values).
- Only use this tool for work which other types of wrenches, which present lower vibration risks, are unable to perform satisfactorily.
- The vibration emission varies greatly with task and operator technique. Emissions outside the quoted range may occur for some applications.
- Operators should optimize their technique and select a suitable wrench in order to minimize the ratcheting time at the end of each run-down or when backing-off assembled fasteners.
- For the intended application of this tool, we estimate that normal operation should involve a ratcheting time against a run-down fastener of less than 0,5s per fastener on a hard joint and up to 3s on a soft joint.

Užitočné informácie

Copyright

© Copyright 2019, Desoutter GmbH, Edmund-Seng-Str. 3-5, 63477 Maintal, Germany

RATCHET WRENCH

Všetky práva vyhradené. Akékoľvek neautorizované použitie alebo kopírovanie obsahu alebo jeho časti je zakázané. Týka sa to predovšetkým obchodných značiek, označení modelov, čísiel dielov a výkresov. Používajte iba autorizované diely. Na akékoľvek škody alebo zlyhania spôsobené používaním neautorizovaných dielov sa nevzťahuje záruka ani ručenie za produkt.

Krajina pôvodu

China

Technické údaje

	RC3068	RC3268	RC3278	RC3678
Rozměr závitu na vs- tupu vzduchu (")	1/4	1/4	1/4	1/4
	BSPP	BSPP	BSPP	BSPP
Otáčky bez zatížení (ot/min)	280	280	190	190
Max. toč. mo- ment (Nm)	45	50	100	100
Max. provozní toč. moment (Nm)	30	25	60	60
Čtyřhranný pohon (")	1/4	3/8	3/8	1/2
Hmotnost (kg)	0.67	0.68	1.22	1.23

	RC3068	RC3268	RC3278	RC3678
Hladina akustického tlaku (dB(A))	92.9	92.9	89.2	89.2
Vibrace (m/s ²)	8.5	8.5	9.2	9.2

Prohlášení

EU PROHLÁŠENÍ O SHODĚ

My, společnost **Desoutter GmbH**, Edmund-Seng-Str. 3-5, 63477 Maintal, Germany, na vlastní odpovědnost prohlašujeme, že produkt (s názvem, typem a sériovým číslem, viz přední strana) splňuje požadavky následujících směrnic: **2006/42/EC (17/05/2006)**

Použité harmonizované normy:
EN ISO 11148-6:2012

Úřady si mohou vyžádat příslušné technické informace od:
Pascal Roussy, R&D Manager, Ets Georges Renault, 38 rue Bobby Sands, BP10273 44818 Saint Herblain, France

Saint-Herblain,

Pascal ROUSSY

Podpis vydavatele



Další informace týkající se vibrací

Tento nástroj, pokud není přiměřeným způsobem používán, může způsobovat vibrační syndrom ruky a paže.

Tyto další informace týkající se vibrací mohou zaměstnavatelům pomoci při plnění jejich povinností (například podle směrnice EU 2002/44/ES) z hlediska vyhodnocování rizik spojených s vibracemi ruky a paže, jimž jsou vystaveni jejich pracovníci při používání tohoto nástroje.

Řehtačkové utahováky jsou vhodné pro montážní a demon-
tažní práce v omezených prostorech.

- The declared vibration value can be used to estimate vibration during rundown. Continuous ratcheting against a run-down bolt may produce a vibration emission in the range m/s² to m/s² (vibration total values).
- Tento nástroj používejte pouze k práci, kterou není možné uspokojivě provádět s jinými typy utahováků, jež představují nižší vibrační riziko.
- Vibrační emise se výrazně liší podle vykonávané práce a techniky operátora. U některých aplikací mohou vznikat emise překračující uvedené rozpětí.
- Operátoři musí optimalizovat své techniky a zvolit vhodný utahovák tak, aby minimalizovali dobu řehtačkového efektu na konci každého doběhu nebo při uvolňování utahovaných upevňovacích prvků.
- For the intended application of this tool, we estimate that normal operation should involve a ratcheting time against a run-down fastener of less than 0,5s per fastener on a hard joint and up to 3s on a soft joint.

Užitečné informace

Copyright

© 2019, Desoutter GmbH, Edmund-Seng-Str. 3-5, 63477 Maintal, Germany

Všechna práva vyhrazena. Veškeré neautorizované použití a kopírování obsahu nebo jeho částí je zakázáno. To platí zejména o obchodních známkách, označeních modelu, číslech součástek a výkresech. Používejte pouze schválené náhradní díly. Jakékoliv škody nebo závady způsobené použitím neschválených dílů nejsou kryty Zárukou ani Odpovědností za produkt.

Země původu

China

Műszaki adatok

	RC3068	RC3268	RC3278	RC3678
Levegőbemenet menetmérete (")	1/4	1/4	1/4	1/4
	BSPP	BSPP	BSPP	BSPP
Üresjárati fordulat- szám (f/p)	280	280	190	190

	RC3068	RC3268	RC3278	RC3678
Maximális nyomaték (Nm)	45	50	100	100
Maximális munkanyomaték (Nm)	30	25	60	60
Négylapfejű hajtóelem (")	1/4	3/8	3/8	1/2
Tömeg (kg)	0.67	0.68	1.22	1.23

	RC3068	RC3268	RC3278	RC3678
Hangnyomás szint (dB(A))	92.9	92.9	89.2	89.2
Vibráció (m/s ²)	8.5	8.5	9.2	9.2

Nyilatkozatok

EU MEGFELELŐSÉGI NYILATKOZAT

Mi, a(z) **Desoutter GmbH**, Edmund-Seng-Str. 3-5, 63477 Maintal, Germany, teljes felelősséggel kijelentjük, hogy a termék (a típust és termékszámot lásd az első oldalon) megfelel a következő direktívá(k)nak:
2006/42/EC (17/05/2006)

Alkalmazott harmonizált szabványok:
EN ISO 11148-6:2012

A hatóságok kérhetik a vonatkozó műszaki információkat:
Pascal Roussy, R&D Manager, Ets Georges Renault, 38 rue Bobby Sands, BP10273 44818 Saint Herblain, France

Saint-Herblain,

Pascal ROUSSY

A kiadó aláírása



Additional Vibration Information

This tool may cause hand-arm vibration syndrome if its use is not adequately managed.

This additional vibration information may be of assistance to employers in meeting their obligations (for example under EU Directive 2002/44/EC) to assess the risks to their workers arising from hand arm vibration associated with the use of this tool.

Ratchet wrenches are suitable for assembly and disassembly operations in confined spaces.

- The declared vibration value can be used to estimate vibration during rundown. Continuous ratcheting against a run-down bolt may produce a vibration emission in the range m/s² to m/s² (vibration total values).
- Only use this tool for work which other types of wrenches, which present lower vibration risks, are unable to perform satisfactorily.

- The vibration emission varies greatly with task and operator technique. Emissions outside the quoted range may occur for some applications.
- Operators should optimize their technique and select a suitable wrench in order to minimize the ratcheting time at the end of each run-down or when backing-off assembled fasteners.
- For the intended application of this tool, we estimate that normal operation should involve a ratcheting time against a run-down fastener of less than 0,5s per fastener on a hard joint and up to 3s on a soft joint.

Hasznos információk

Copyright

© Szerzői jog 2019, Desoutter GmbH, Edmund-Seng-Str. 3-5, 63477 Maintal, Germany

Minden jog fenntartva. A tartalom vagy annak bármely részének jogosulatlan használata vagy másolása tilos. Ez különösképpen vonatkozik a védjegyekre, a modellek megnevezéseire, az alkatrészszámokra és a rajzokra. Kizárólag engedélyezett alkatrészeket használjon. A nem engedélyezett alkatrészek használatából eredő bármilyen meghibásodásra vagy károsodásra a Jótállás és Termékfelelősség feltételei nem vonatkoznak.

Származási ország

China

Tehnični podatki

	RC3068	RC3268	RC3278	RC3678
Velikost navoja zračnega vhoda (palci)	1/4	1/4	1/4	1/4
	BSPP	BSPP	BSPP	BSPP
Hitrost v prostem teku (obr/min)	280	280	190	190
Maks. navor (Nm)	45	50	100	100
Maks. delovni navor (Nm)	30	25	60	60
Kvadratni nasadni nas-tavek (palci)	1/4	3/8	3/8	1/2
Teža (kg)	0.67	0.68	1.22	1.23

	RC3068	RC3268	RC3278	RC3678
Raven zvočnega tlaka (dB(A))	92.9	92.9	89.2	89.2
Vibracije (m/s ²)	8.5	8.5	9.2	9.2

RATCHET WRENCH

Izjave

IZJAVA EU O SKLADNOSTI

V družbi **Desoutter GmbH**, Edmund-Seng-Str. 3-5, 63477 Maintal, Germany, na izključno lastno odgovornost izjavljamo, da je izdelek (z imenom, tipom in serijsko številko z naslovnice) skladen z naslednjimi direktivami:
2006/42/EC (17/05/2006)

Uporabljeni usklajeni standardi:
EN ISO 11148-6:2012

Pristojni organ lahko zaprosi za pridobitev potrebnih tehničnih podatkov pri:
Pascal Roussy, R&D Manager, Ets Georges Renault, 38 rue Bobby Sands, BP10273 44818 Saint Herblain, France

Saint-Herblain,

Pascal ROUSSY

Podpis izdajatelja

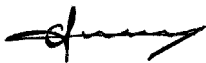

Additional Vibration Information

This tool may cause hand-arm vibration syndrome if its use is not adequately managed.

This additional vibration information may be of assistance to employers in meeting their obligations (for example under EU Directive 2002/44/EC) to assess the risks to their workers arising from hand arm vibration associated with the use of this tool.

Ratchet wrenches are suitable for assembly and disassembly operations in confined spaces.

- The declared vibration value can be used to estimate vibration during rundown. Continuous ratcheting against a run-down bolt may produce a vibration emission in the range m/s^2 to m/s^2 (vibration total values).
- Only use this tool for work which other types of wrenches, which present lower vibration risks, are unable to perform satisfactorily.
- The vibration emission varies greatly with task and operator technique. Emissions outside the quoted range may occur for some applications.
- Operators should optimize their technique and select a suitable wrench in order to minimize the ratcheting time at the end of each run-down or when backing-off assembled fasteners.
- For the intended application of this tool, we estimate that normal operation should involve a ratcheting time against a run-down fastener of less than 0,5s per fastener on a hard joint and up to 3s on a soft joint.

Koristne informacije

Avtorske pravice

© Avtorske pravice 2019, Desoutter GmbH, Edmund-Seng-Str. 3-5, 63477 Maintal, Germany

Vse pravice pridržane. Vsaka nepooblaščen uporaba ali razmnoževanje vsebine ali delov vsebine je prepovedano. To še posebej velja za blagovne znamke, označbe modelov, številke delov in slike. Uporabite samo pooblaščen dele. Garancija ali jamstvo za izdelek ne krije nobenih poškodb ali nepravilnega delovanja, ki ga povzroči uporaba nepooblaščenih delov.

Država izvora

China

Date tehnice

	RC3068	RC3268	RC3278	RC3678
dimensiune filet admisije aer (")	1/4	1/4	1/4	1/4
	BSPP	BSPP	BSPP	BSPP
Turație la gol (rpm)	280	280	190	190
Cuplu max. (Nm)	45	50	100	100
Cuplu util max. (Nm)	30	25	60	60
Antrenor pătrat (")	1/4	3/8	3/8	1/2
Greutate (kg)	0.67	0.68	1.22	1.23

	RC3068	RC3268	RC3278	RC3678
Nivel presiune sunet (dB(A))	92.9	92.9	89.2	89.2
Vibrație (m/s ²)	8.5	8.5	9.2	9.2

Declarații

DECLARAȚIE DE CONFORMITATE UE

Noi, **Desoutter GmbH**, Edmund-Seng-Str. 3-5, 63477 Maintal, Germany, declarăm pe propria răspundere că produsul (cu denumirea, tipul și numărul de serie - vezi prima pagină) este conform cu următoarea Directivă / următoarele Directive:

2006/42/EC (17/05/2006)

Standarde armonizate aplicate:

EN ISO 11148-6:2012

Autoritățile pot solicita informații tehnice corespunzătoare de la:

Pascal Roussy, R&D Manager, Ets Georges Renault, 38 rue Bobby Sands, BP10273 44818 Saint Herblain, France

Saint-Herblain,

Pascal ROUSSY

Semnătura emitentului



Additional Vibration Information

This tool may cause hand-arm vibration syndrome if its use is not adequately managed.

This additional vibration information may be of assistance to employers in meeting their obligations (for example under EU Directive 2002/44/EC) to assess the risks to their workers arising from hand arm vibration associated with the use of this tool.

Ratchet wrenches are suitable for assembly and disassembly operations in confined spaces.

- The declared vibration value can be used to estimate vibration during rundown. Continuous ratcheting against a run-down bolt may produce a vibration emission in the range m/s^2 to m/s^2 (vibration total values).
- Only use this tool for work which other types of wrenches, which present lower vibration risks, are unable to perform satisfactorily.
- The vibration emission varies greatly with task and operator technique. Emissions outside the quoted range may occur for some applications.
- Operators should optimize their technique and select a suitable wrench in order to minimize the ratcheting time at the end of each run-down or when backing-off assembled fasteners.
- For the intended application of this tool, we estimate that normal operation should involve a ratcheting time against a run-down fastener of less than 0,5s per fastener on a hard joint and up to 3s on a soft joint.

Informații utile

Drepturi de autor

© Copyright 2019, Desoutter GmbH, Edmund-Seng-Str. 3-5, 63477 Maintal, Germany

Toate drepturile rezervate. Este interzisă utilizarea sau copierea integrală sau parțială a conținutului. Acest lucru este valabil pentru mărcile comerciale, denumirile modelelor, numerele componentelor și schițe. A se utiliza exclusiv piese autorizate. Eventualele deteriorări sau defecțiuni cauzate prin utilizarea de piese neautorizate nu este acoperită de garanție nici de certificatul de conformitate.

Țara de origine

China

Teknik Veriler

	RC3068	RC3268	RC3278	RC3678
Hava girişi vida dişi boyutu (")	1/4	1/4	1/4	1/4
	BSPP	BSPP	BSPP	BSPP
Serbest hız (dev/dk)	280	280	190	190
Maks. tork (Nm)	45	50	100	100

	RC3068	RC3268	RC3278	RC3678
Maks. çalışma torku (Nm)	30	25	60	60
Kare tahrik (")	1/4	3/8	3/8	1/2
Ağırlık (kg)	0.67	0.68	1.22	1.23

	RC3068	RC3268	RC3278	RC3678
Ses basıncı seviyesi (dB(A))	92.9	92.9	89.2	89.2
Titreşim (m/s^2)	8.5	8.5	9.2	9.2

Beyanlar

AB UYGUNLUK BEYANI

Bizler, **Desoutter GmbH**, Edmund-Seng-Str. 3-5, 63477 Maintal, Germany olarak, kendi münhasır sorumluluğumuz altında ürünün (adı, tipi ve seri numarası ile ön sayfaya bakınız) aşağıdaki Direktif(ler) ile uyumlu olduğunu beyan ederiz:

2006/42/EC (17/05/2006)

Geçerli dengelenmiş standartlar:
EN ISO 11148-6:2012

Yetkili makamlar ilgili teknik bilgileri şuradan isteyebilir:
Pascal Roussy, R&D Manager, Ets Georges Renault, 38 rue Bobby Sands, BP10273 44818 Saint Herblain, France
Saint-Herblain,

Pascal ROUSSY

Yayınlayanın imzası



Additional Vibration Information

This tool may cause hand-arm vibration syndrome if its use is not adequately managed.

This additional vibration information may be of assistance to employers in meeting their obligations (for example under EU Directive 2002/44/EC) to assess the risks to their workers arising from hand arm vibration associated with the use of this tool.

Ratchet wrenches are suitable for assembly and disassembly operations in confined spaces.

- The declared vibration value can be used to estimate vibration during rundown. Continuous ratcheting against a run-down bolt may produce a vibration emission in the range m/s^2 to m/s^2 (vibration total values).
- Only use this tool for work which other types of wrenches, which present lower vibration risks, are unable to perform satisfactorily.
- The vibration emission varies greatly with task and operator technique. Emissions outside the quoted range may occur for some applications.

RATCHET WRENCH

- Operators should optimize their technique and select a suitable wrench in order to minimize the ratcheting time at the end of each run-down or when backing-off assembled fasteners.
- For the intended application of this tool, we estimate that normal operation should involve a ratcheting time against a run-down fastener of less than 0,5s per fastener on a hard joint and up to 3s on a soft joint.

Faydalı Bilgiler

Telif Hakkı

© Telif hakkı 2019, Desoutter GmbH, Edmund-Seng-Str. 3-5, 63477 Maintal, Germany

Tüm hakları saklıdır. İçeriğin veya bir kısmının her türlü yetkisiz kullanımı veya kopyalanması yasaktır. Bu özellikte ticari markalar, model adları, parça numaraları ve çizimler için geçerlidir. Sadece yetkili parçaları kullanın. Onaylanmamış parçaların kullanımı nedeniyle oluşan zararlar veya arızalar Garanti veya Ürün Sorumluluğu kapsamına girmez.

Menşei ülke

China

Технически данни

	RC3068	RC3268	RC3278	RC3678
Отвор за приток на въздух - размер на резбата (")	1/4	1/4	1/4	1/4
	BSPP	BSPP	BSPP	BSPP
Свободна скорост (rpm)	280	280	190	190
Макс. усукване (Nm)	45	50	100	100
Макс. работен усукв. момент (Nm)	30	25	60	60
Квадратно задвижване (")	1/4	3/8	3/8	1/2
Тегло (kg)	0.67	0.68	1.22	1.23

	RC3068	RC3268	RC3278	RC3678
Ниво на звуково налягане (dB(A))	92.9	92.9	89.2	89.2
Вибрация (m/s ²)	8.5	8.5	9.2	9.2

Декларации

ЕС ДЕКЛАРАЦИЯ ЗА СЪОТВЕТСТВИЕ

Ние, **Desoutter GmbH**, Edmund-Seng-Str. 3-5, 63477 Maintal, Germany, декларираме на своя лична отговорност, че този продукт (с име, тип и сериен номер,

вижте предната страница) е в съответствие със следната(ите) Директива(и):
2006/42/EC (17/05/2006)

Приложени хармонизирани стандарти:
EN ISO 11148-6:2012

Властите могат да поискат съответната техническа информация от:
Pascal Roussy, R&D Manager, Ets Georges Renault, 38 rue Bobby Sands, BP10273 44818 Saint Herblain, France
Saint-Herblain,

Pascal ROUSSY

Подпис на издаващото лице

Additional Vibration Information

This tool may cause hand-arm vibration syndrome if its use is not adequately managed.

This additional vibration information may be of assistance to employers in meeting their obligations (for example under EU Directive 2002/44/EC) to assess the risks to their workers arising from hand arm vibration associated with the use of this tool.

Ratchet wrenches are suitable for assembly and disassembly operations in confined spaces.

- The declared vibration value can be used to estimate vibration during rundown. Continuous ratcheting against a run-down bolt may produce a vibration emission in the range m/s² to m/s² (vibration total values).
- Only use this tool for work which other types of wrenches, which present lower vibration risks, are unable to perform satisfactorily.
- The vibration emission varies greatly with task and operator technique. Emissions outside the quoted range may occur for some applications.
- Operators should optimize their technique and select a suitable wrench in order to minimize the ratcheting time at the end of each run-down or when backing-off assembled fasteners.
- For the intended application of this tool, we estimate that normal operation should involve a ratcheting time against a run-down fastener of less than 0,5s per fastener on a hard joint and up to 3s on a soft joint.

Полезна информация

Авторско право

© Copyright 2019, Desoutter GmbH, Edmund-Seng-Str. 3-5, 63477 Maintal, Germany

Всички права запазени. Забранява се всяко неразрешено използване или копиране на съдържанието или част от него. Това се отнася в частност за търговски марки, названия на модела, номера на части и чертежи. Използвайте само оригинални резервни части. Повреди

или неизправности вследствие на употреба на неоригинални части не се покриват от гаранцията или отговорността за вреди, причинени от продукта.

Произход на продукта

China

Tehnički podaci

	RC3068	RC3268	RC3278	RC3678
Veličina navoja ulaza zraka (")	1/4	1/4	1/4	1/4
	BSPP	BSPP	BSPP	BSPP
Slobodna brzina vrtnje (o/min)	280	280	190	190
Maks. zakretni moment (Nm)	45	50	100	100
Maks. radni zakretni moment (Nm)	30	25	60	60
Kvadratni utor (")	1/4	3/8	3/8	1/2
Masa (kg)	0.67	0.68	1.22	1.23

	RC3068	RC3268	RC3278	RC3678
Razina zvučnog tlaka (db(A))	92.9	92.9	89.2	89.2
Vibracije (m/s ²)	8.5	8.5	9.2	9.2

Izjave

EU IZJAVA O SUKLADNOSTI

Mi, **Desoutter GmbH**, Edmund-Seng-Str. 3-5, 63477 Maintal, Germany, izjavljujemo pod vlastitom odgovornošću da je proizvod (naziv, tip i serijski broj, vidi naslovnu stranu) u skladu sa sljedećom(im) direktivom(ama):

2006/42/EC (17/05/2006)

Primijenjene usklađene norme:

EN ISO 11148-6:2012

Nadležna tijela mogu zahtijevati relevantne tehničke podatke od:

Pascal Roussy, R&D Manager, Ets Georges Renault, 38 rue Bobby Sands, BP10273 44818 Saint Herblain, France

Saint-Herblain,

Pascal ROUSSY

Potpis izdavatelja



Dodatne informacije o vibracijama

Ovaj alat može izazvati sindrom vibriranja ruke ako se njime ne rukuje na odgovarajući način.

Ove dodatne informacije o vibracijama mogu pomoći poslodavcima u ispunjavanju njihovih obveza (na primjer u skladu s Direktivom EU 2002/44/EZ) u pogledu procjene rizika za njihove radnike koji proizlaze iz vibracija koje djeluju na šaku i ruku pri uporabi ovog alata.

Ratchet wrenches are suitable for assembly and disassembly operations in confined spaces.

- The declared vibration value can be used to estimate vibration during rundown. Continuous ratcheting against a run-down bolt may produce a vibration emission in the range m/s² to m/s² (vibration total values).
- Only use this tool for work which other types of wrenches, which present lower vibration risks, are unable to perform satisfactorily.
- Emisija vibracija uvelike se razlikuje ovisno o zadatku i tehnici rukovatelja. Kod nekih primjena može doći do emisija izvan navednog raspona.
- Operators should optimize their technique and select a suitable wrench in order to minimize the ratcheting time at the end of each run-down or when backing-off assembled fasteners.
- For the intended application of this tool, we estimate that normal operation should involve a ratcheting time against a run-down fastener of less than 0,5s per fastener on a hard joint and up to 3s on a soft joint.

Korisne informacije

Autorsko pravo

© Autorsko pravo 2019, Desoutter GmbH, Edmund-Seng-Str. 3-5, 63477 Maintal, Germany

Sva su prava pridržana. Zabranjena je svaka neovlaštena uporaba ili kopiranje sadržaja ili njegovog dijela. To se posebno odnosi na zaštitne znakove, oznake modela, brojeve dijelova i crteže. Upotrebljavajte samo odobrene dijelove. Jamstvo ili odgovornost za proizvod ne obuhvaćaju bilo kakva oštećenja ili kvarove izazvane uporabom neodobrenih dijelova.

Zemlja podrijetla

China

Tehnilised andmed

	RC3068	RC3268	RC3278	RC3678
Õhu sisselaske keerme suurus (")	1/4	1/4	1/4	1/4
	BSPP	BSPP	BSPP	BSPP
Tühikäigukiirus (p/min)	280	280	190	190
Max. väändejõud (Nm)	45	50	100	100
Max. tööväändejõud (Nm)	30	25	60	60

RATCHET WRENCH

	RC3068	RC3268	RC3278	RC3678
Nelinurkajam (")	1/4	3/8	3/8	1/2
Kaal (kg)	0.67	0.68	1.22	1.23

	RC3068	RC3268	RC3278	RC3678
Helirõhutase (dB(A))	92.9	92.9	89.2	89.2
Vibratsioon (m/s ²)	8.5	8.5	9.2	9.2

Deklaratsioon

EL-I VASTAVUSDEKLARATSIOON

Meie, **Desoutter GmbH**, Edmund-Seng-Str. 3-5, 63477 Maintal, Germany, deklareerime oma täielikul vastutusel, et toode (nime, tüübi ja seerianumbri leiate esilehelt) on vastavuses järgmis(t)e direktiivi(de)ga:
2006/42/EC (17/05/2006)

Kohalduvad harmoneeritud standardid:
EN ISO 11148-6:2012

Ametiasutused võivad nõuda asjakohast tehnilist teavet, mille peab saatma:
Pascal Roussy, R&D Manager, Ets Georges Renault, 38 rue Bobby Sands, BP10273 44818 Saint Herblain, France

Saint-Herblain,

Pascal ROUSSY

Väljaandja allkiri

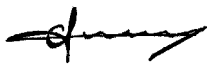

Additional Vibration Information

This tool may cause hand-arm vibration syndrome if its use is not adequately managed.

This additional vibration information may be of assistance to employers in meeting their obligations (for example under EU Directive 2002/44/EC) to assess the risks to their workers arising from hand arm vibration associated with the use of this tool.

Ratchet wrenches are suitable for assembly and disassembly operations in confined spaces.

- The declared vibration value can be used to estimate vibration during rundown. Continuous ratcheting against a run-down bolt may produce a vibration emission in the range m/s^2 to m/s^2 (vibration total values).
- Only use this tool for work which other types of wrenches, which present lower vibration risks, are unable to perform satisfactorily.
- The vibration emission varies greatly with task and operator technique. Emissions outside the quoted range may occur for some applications.
- Operators should optimize their technique and select a suitable wrench in order to minimize the ratcheting time at the end of each run-down or when backing-off assembled fasteners.

- For the intended application of this tool, we estimate that normal operation should involve a ratcheting time against a run-down fastener of less than 0,5s per fastener on a hard joint and up to 3s on a soft joint.

Kasulik teave

Autoriõigus

© Autoriõigus 2019, Desoutter GmbH, Edmund-Seng-Str. 3-5, 63477 Maintal, Germany

Kõik õigused kaitstud. Volitamata kasutamine või sisu või selle osa kopeerimine on keelatud. See puudutab konkreetset just kaubamärke, mudelite nimetusi, detailide numbreid ja jooniseid. Kasutage ainult heakskiidetud osi. Autoriseerimata osade kasutamisest põhjustatud kahjustused või tõrked pole garantii või toote vastutuse poolt kaetud.

Päritolumaa

China

Techniniai duomenys

	RC3068	RC3268	RC3278	RC3678
Oro įleidimo angos sriegio dydis (")	1/4	1/4	1/4	1/4
	BSPP	BSPP	BSPP	BSPP
Tuščiosios eigos ap-sukos (aps./min.)	280	280	190	190
Maks. sukimo momen-tas (Nm)	45	50	100	100
Maks. darbinis sukimo momentas (Nm)	30	25	60	60
Kvadratinė jungtis (")	1/4	3/8	3/8	1/2
Svoris (kg)	0.67	0.68	1.22	1.23

	RC3068	RC3268	RC3278	RC3678
Garso slėgio lygis (dB(A))	92.9	92.9	89.2	89.2
Vibracijos (m/sek. ²)	8.5	8.5	9.2	9.2

Deklaracijos

ES ATITIKTIES DEKLARACIJA

Mes, **Desoutter GmbH**, Edmund-Seng-Str. 3-5, 63477 Maintal, Germany, vienašališkos atsakomybės pagrindu pareiškiame, kad gaminy (pavadinimą, tipinį ir serijos numerį žr. pirmame puslapyje), atitinka šią (-as) Direktyvą (-as):

2006/42/EC (17/05/2006)

Taikyti darnieji standartai:
EN ISO 11148-6:2012

Atitinkamos techninės informacijos institucijos gali pareikalauti iš:
Pascal Roussy, R&D Manager, Ets Georges Renault, 38 rue Bobby Sands, BP10273 44818 Saint Herblain, France

Saint-Herblain,
Pascal ROUSSY
Išdavėjo parašas



Additional Vibration Information

This tool may cause hand-arm vibration syndrome if its use is not adequately managed.

This additional vibration information may be of assistance to employers in meeting their obligations (for example under EU Directive 2002/44/EC) to assess the risks to their workers arising from hand arm vibration associated with the use of this tool.

Ratchet wrenches are suitable for assembly and disassembly operations in confined spaces.

- The declared vibration value can be used to estimate vibration during rundown. Continuous ratcheting against a run-down bolt may produce a vibration emission in the range m/s^2 to m/s^2 (vibration total values).
- Only use this tool for work which other types of wrenches, which present lower vibration risks, are unable to perform satisfactorily.
- The vibration emission varies greatly with task and operator technique. Emissions outside the quoted range may occur for some applications.
- Operators should optimize their technique and select a suitable wrench in order to minimize the ratcheting time at the end of each run-down or when backing-off assembled fasteners.
- For the intended application of this tool, we estimate that normal operation should involve a ratcheting time against a run-down fastener of less than 0,5s per fastener on a hard joint and up to 3s on a soft joint.

Naudinga informacija

Autorių teisės

© Copyright 2019, Desoutter GmbH, Edmund-Seng-Str. 3-5, 63477 Maintal, Germany

Visos teisės saugomos. Draudžiamas bet koks šio turinio ar jo dalies naudojimas arba kopijavimas neturint tam leidimo. Tai ypač taikoma prekių ženklams, modelių pavadinimams, dalių numeriams ir brėžiniams. Naudokite tik leistas dalis. Jei gaminys veiks blogai arba suges dėl neleistinų dalių naudojimo, garantija nebus taikoma.

Kilmės šalis

China

Tehniskie dati

	RC3068	RC3268	RC3278	RC3678
Gaisa ieplydės vītės izmērs (collas)	1/4	1/4	1/4	1/4
	BSPP	BSPP	BSPP	BSPP
Brīvais ātrums (apgr./min.)	280	280	190	190
Maks. griezes moments (Nm)	45	50	100	100
Maks. darba griezes moments (Nm)	30	25	60	60
Četrstūra gals (collas)	1/4	3/8	3/8	1/2
Svars (kg)	0.67	0.68	1.22	1.23

	RC3068	RC3268	RC3278	RC3678
Skaņas spiediena līmenis (dB(A))	92.9	92.9	89.2	89.2
Vibrācija (m/s^2)	8.5	8.5	9.2	9.2

Deklarācijas

ES ATBILSTĪBAS DEKLARĀCIJA

Mēs, **Desoutter GmbH**, Edmund-Seng-Str. 3-5, 63477 Maintal, Germany, vienpersoniski uzņēmoties atbildību, paziņojam, ka produkts (ar nosaukumu, tipu un sērijas numuru, kas atrodami titullapā) atbilst šai direktīvai(-ām): **2006/42/EC (17/05/2006)**

Piemērotie saskaņotie standarti:
EN ISO 11148-6:2012

Iestādes var pieprasīt nepieciešamo tehnisko informāciju no: Pascal Roussy, R&D Manager, Ets Georges Renault, 38 rue Bobby Sands, BP10273 44818 Saint Herblain, France

Saint-Herblain,
Pascal ROUSSY
Izsniedzēja paraksts



Additional Vibration Information

This tool may cause hand-arm vibration syndrome if its use is not adequately managed.

This additional vibration information may be of assistance to employers in meeting their obligations (for example under EU Directive 2002/44/EC) to assess the risks to their workers arising from hand arm vibration associated with the use of this tool.

Ratchet wrenches are suitable for assembly and disassembly operations in confined spaces.

RATCHET WRENCH

- The declared vibration value can be used to estimate vibration during rundown. Continuous ratcheting against a run-down bolt may produce a vibration emission in the range m/s^2 to m/s^2 (vibration total values).
- Only use this tool for work which other types of wrenches, which present lower vibration risks, are unable to perform satisfactorily.
- The vibration emission varies greatly with task and operator technique. Emissions outside the quoted range may occur for some applications.
- Operators should optimize their technique and select a suitable wrench in order to minimize the ratcheting time at the end of each run-down or when backing-off assembled fasteners.
- For the intended application of this tool, we estimate that normal operation should involve a ratcheting time against a run-down fastener of less than 0,5s per fastener on a hard joint and up to 3s on a soft joint.

Noderīga informācija

Autortiesības

© Autortiesības 2019, Desoutter GmbH, Edmund-Seng-Str. 3-5, 63477 Maintal, Germany

Visas tiesības paturētas. Satura vai tā daļas neatļauta izmantošana vai kopēšana ir aizliegta. It sevišķi tas attiecas uz preču zīmēm, modeļu nosaukumiem, daļu numuriem un rasējumiem. Izmantojiet tikai atļautas daļas. Bojājumus vai darbības traucējumus, kurus izraisījusi neatļautu daļu lietošana, nesedz garantija vai ražotāja atbildība par produktu.

Izcelsmes valsts

China

技术数据

	RC3068	RC3268	RC3278	RC3678
进气口螺纹尺寸 (")	1/4	1/4	1/4	1/4
	BSPP	BSPP	BSPP	BSPP
空载转速 (转/分钟)	280	280	190	190
最大扭矩 (Nm)	45	50	100	100
最大工作扭矩 (Nm)	30	25	60	60
驱动方头 (")	1/4	3/8	3/8	1/2
重量 (kg)	0.67	0.68	1.22	1.23

	RC3068	RC3268	RC3278	RC3678
声压水平 (dB(A))	92.9	92.9	89.2	89.2
振动 (m/s^2)	8.5	8.5	9.2	9.2

声明

EU 符合性声明

我们 (Desoutter GmbH, Edmund-Seng-Str. 3-5, 63477 Maintal, Germany) 全权声明, 本产品 (名称、型号和序列号, 请见首页) 符合以下指令:

2006/42/EC (17/05/2006)

应用的协调标准:

EN ISO 11148-6:2012

机构能从

Pascal Roussy, R&D Manager, Ets Georges Renault, 38 rue Bobby Sands, BP10273 44818 Saint Herblain, France 获取技术信息

Saint-Herblain,

Pascal ROUSSY

签发者签名

附加振动信息

This tool may cause hand-arm vibration syndrome if its use is not adequately managed.

This additional vibration information may be of assistance to employers in meeting their obligations (for example under EU Directive 2002/44/EC) to assess the risks to their workers arising from hand arm vibration associated with the use of this tool.

棘轮扳手适用于在有限空间内进行组装和拆卸工作。

- The declared vibration value can be used to estimate vibration during rundown. Continuous ratcheting against a run-down bolt may produce a vibration emission in the range m/s^2 to m/s^2 (vibration total values).
- 只允许采用本工具进行工作, 其他类型的低振动风险扳手无法达到要求。
- The vibration emission varies greatly with task and operator technique. Emissions outside the quoted range may occur for some applications.
- 在每次拆卸或者拆卸组装紧固件时, 操作人员应该优化技能, 并选择适当的扳手来最大化缩短松脱时间。
- 关于本工具的预期应用, 我们预计在正常操作下, 对于硬接头上的紧固件, 每个紧固件松脱时间不超过 0.5 秒, 如果是软接头, 则最长不超过 3 秒。

有用的信息

版权所有

© 版权所有 2019, Desoutter GmbH, Edmund-Seng-Str. 3-5, 63477 Maintal, Germany

保留所有权限。禁止对此内容或其部分内容进行任何未经授权的使用或复制。本规定专门适用于商标、型号名称、部件编号和图纸。请仅使用经授权的部件。保修或产品责任不包括任何由于使用未经授权的部件而造成的损坏或故障。

原産地

China

技術データ

	RC3068	RC3268	RC3278	RC3678
空気吸入口サイズ (インチ)	1/4	1/4	1/4	1/4
	BSPP	BSPP	BSPP	BSPP
自由速度 (rpm)	280	280	190	190
最大トルク (Nm)	45	50	100	100
最大作動トルク (Nm)	30	25	60	60
スクエアドライブ (インチ)	1/4	3/8	3/8	1/2
重量 (kg)	0.67	0.68	1.22	1.23

	RC3068	RC3268	RC3278	RC3678
音圧レベル (dB(A))	92.9	92.9	89.2	89.2
振動 (m/s ²)	8.5	8.5	9.2	9.2

宣言

EU 適合宣言

弊社Desoutter GmbH, Edmund-Seng-Str. 3-5, 63477 Maintal, Germanyは、弊社製品 (名称、タイプ、およびシリアル番号あり、フロントページ参照) が次の指令に準拠していることを、当社のもっぱらの責任の下で宣言します:

2006/42/EC (17/05/2006)

適用する整合規格:

EN ISO 11148-6:2012

当局は、以下から関連する技術情報を取得できます。
Pascal Roussy, R&D Manager, Ets Georges Renault, 38 rue Bobby Sands, BP10273 44818 Saint Herblain, France

Saint-Herblain,

Pascal ROUSSY

発行者による署名

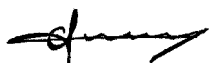

Additional Vibration Information

This tool may cause hand-arm vibration syndrome if its use is not adequately managed.

This additional vibration information may be of assistance to employers in meeting their obligations (for example under EU Directive 2002/44/EC) to assess the risks to their workers arising from hand arm vibration associated with the use of this tool.

Ratchet wrenches are suitable for assembly and disassembly operations in confined spaces.

- The declared vibration value can be used to estimate vibration during rundown. Continuous ratcheting against a run-down bolt may produce a vibration emission in the range m/s² to m/s² (vibration total values).
- Only use this tool for work which other types of wrenches, which present lower vibration risks, are unable to perform satisfactorily.
- The vibration emission varies greatly with task and operator technique. Emissions outside the quoted range may occur for some applications.
- Operators should optimize their technique and select a suitable wrench in order to minimize the ratcheting time at the end of each run-down or when backing-off assembled fasteners.
- For the intended application of this tool, we estimate that normal operation should involve a ratcheting time against a run-down fastener of less than 0,5s per fastener on a hard joint and up to 3s on a soft joint.

有用な情報

著作権

© 著作権 2019, Desoutter GmbH, Edmund-Seng-Str. 3-5, 63477 Maintal, Germany

無断複写・複製・転載を禁ず。本書の内容の一部または全部を無断転載あるいは不正使用することは禁止されています。上記禁止行為は、特に商標、モデルの文書化、部品番号および図面に適用されます。認可済みの部品のみ使用してください。未認可の部品の使用によって引き起こされる一切の損傷または誤動作は、保証責任または製造物責任の対象とはなりません。

生産国

China

기술 자료

	RC3068	RC3268	RC3278	RC3678
공기입구 스레드 크기(")	1/4	1/4	1/4	1/4
	BSPP	BSPP	BSPP	BSPP
자유 속도(rpm)	280	280	190	190
최대 토크(Nm)	45	50	100	100
최대 작동 토크(Nm)	30	25	60	60
스퀘어 드라이브(")	1/4	3/8	3/8	1/2
중량(kg)	0.67	0.68	1.22	1.23

	RC3068	RC3268	RC3278	RC3678
음압 레벨(dB(A))	92.9	92.9	89.2	89.2
진동(m/s ²)	8.5	8.5	9.2	9.2

선언

EU 적합성 선언

Desoutter GmbH, Edmund-Seng-Str. 3-5, 63477 Maintal, Germany은(는) 제품(이름, 종류 및 일련번호 포함, 일면 참조)이 다음 지침을 준수하고 있음을 당사의 전적인 책임 하에 선언합니다.

2006/42/EC (17/05/2006)

합의 표준 적용:

EN ISO 11148-6:2012

관련 기술 정보는 관계 당국에서만 요청할 수 있음:

Pascal Roussy, R&D Manager, Ets Georges Renault, 38 rue Bobby Sands, BP10273 44818 Saint Herblain, France

Saint-Herblain,

Pascal ROUSSY

발행자 서명

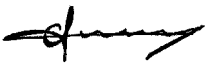

Additional Vibration Information

This tool may cause hand-arm vibration syndrome if its use is not adequately managed.

This additional vibration information may be of assistance to employers in meeting their obligations (for example under EU Directive 2002/44/EC) to assess the risks to their workers arising from hand arm vibration associated with the use of this tool.

Ratchet wrenches are suitable for assembly and disassembly operations in confined spaces.

- The declared vibration value can be used to estimate vibration during rundown. Continuous ratcheting against a run-down bolt may produce a vibration emission in the range m/s^2 to m/s^2 (vibration total values).
- Only use this tool for work which other types of wrenches, which present lower vibration risks, are unable to perform satisfactorily.
- The vibration emission varies greatly with task and operator technique. Emissions outside the quoted range may occur for some applications.
- Operators should optimize their technique and select a suitable wrench in order to minimize the ratcheting time at the end of each run-down or when backing-off assembled fasteners.
- For the intended application of this tool, we estimate that normal operation should involve a ratcheting time against a run-down fastener of less than 0,5s per fastener on a hard joint and up to 3s on a soft joint.

유용한 정보

저작권

© Copyright 2019, Desoutter GmbH, Edmund-Seng-Str. 3-5, 63477 Maintal, Germany

모든 권리 보유. 본 문서의 내용 또는 내용의 일부에 대한 비 승인된 모든 사용 또는 복사 행위는 엄격히 금지됩니다. 이는 특히, 상표, 모델 명칭, 부품 번호 및 도면에 적용됩니다. 승인된 부품만 사용하십시오. 비 인가된 부품을 사용함으로써 인해 발생하는 모든 손상 또는 고장은 보증 또는 생산물 책임 범위에 포함되지 않습니다.

원산지 국가

China

Original instructions
Traduction de la notice originale
Übersetzung der Originalbetriebsanleitung
Traducción de las instrucciones originales
Tradução das instruções originais
Traduzione delle istruzioni originali
Vertaling van oorspronkelijke instructies
Oversættelse af originalvejledning
Oversættelse av originalinstruksjoner.
Käännös alkuperäisistä ohjeista
Μετάφραση πρωτότυπων οδηγιών
Översättning av ursprungliga instruktioner
Перевод оригиналов инструкций
Tłumaczenie oryginalnej instrukcji

Preklad originálnych pokynov
Překlad původních pokynů
Eredeti utasítások fordítása
Prevod izvirnih navodil
Traducerea instrucțiunilor originale
Orijinal talimatların çevirisi
Превод на оригиналните инструкции
Prijevod originalnih uputa
Originaaljuhiste tõlge
Originalių instrukcijų vertimas
Oriģinālo instrukciju tulkojums
原始说明的翻译
使用說明書初出翻譯
원본 설명서의 번역문